

CD4093BM/CD4093BC Quad 2-Input NAND Schmitt Trigger

General Description

The CD4093B consists of four Schmitt-trigger circuits. Each circuit functions as a 2-input NAND gate with Schmitt-trigger action on both inputs. The gate switches at different points for positive and negative-going signals. The difference between the positive (V_{T+}) and the negative voltage (V_{T-}) is defined as hysteresis voltage (V_H).

All outputs have equal source and sink currents and conform to standard B-series output drive (see Static Electrical Characteristics).

Features

- Wide supply voltage range 3.0V to 15V
- Schmitt-trigger on each input with no external components
- Noise immunity greater than 50%

- Equal source and sink currents
- No limit on input rise and fall time
- Standard B-series output drive
- Hysteresis voltage (any input) $T_A = 25^\circ\text{C}$

Typical	$V_{DD} = 5.0\text{V}$	$V_H = 1.5\text{V}$
	$V_{DD} = 10\text{V}$	$V_H = 2.2\text{V}$
	$V_{DD} = 15\text{V}$	$V_H = 2.7\text{V}$
Guaranteed		$V_H = 0.1 V_{DD}$

Applications

- Wave and pulse shapers
- High-noise-environment systems
- Monostable multivibrators
- Astable multivibrators
- NAND logic

Connection Diagram

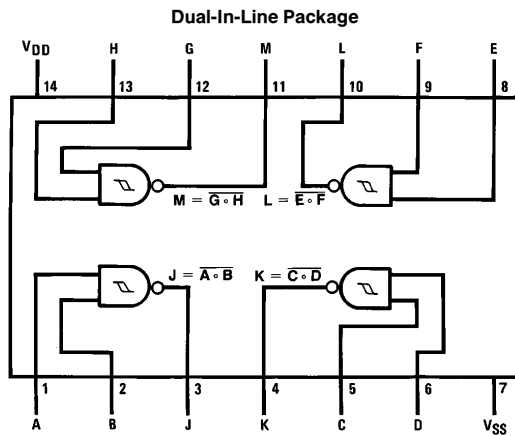

TL/F/5982-1

Top View

Order Number CD4093B

CD4093BM/CD4093BC Quad 2-Input NAND Schmitt Trigger

Absolute Maximum Ratings (Notes 1 & 2)

If Military/Aerospace specified devices are required, please contact the National Semiconductor Sales Office/Distributors for availability and specifications.

DC Supply Voltage (V_{DD})	-0.5 to +18 V_{DC}
Input Voltage (V_{IN})	-0.5 to V_{DD} + 0.5 V_{DC}
Storage Temperature Range (T_S)	-65°C to +150°C
Power Dissipation (P_D)	
Dual-In-Line	700 mW
Small Outline	500 mW
Lead Temperature (T_L)	
(Soldering, 10 seconds)	260°C

Recommended Operating Conditions (Note 2)

DC Supply Voltage (V_{DD})	3 to 15 V_{DC}
Input Voltage (V_{IN})	0 to V_{DD} V_{DC}
Operating Temperature Range (T_A)	
CD4093BM	-55°C to +125°C
CD4093BC	-40°C to +85°C

DC Electrical Characteristics CD4093BM (Note 2)

Symbol	Parameter	Conditions	-55°C		+25°C			+125°C		Units
			Min	Max	Min	Typ	Max	Min	Max	
I_{DD}	Quiescent Device Current	$V_{DD} = 5V$		0.25			0.25		7.5	μA
		$V_{DD} = 10V$		0.5			0.5		15.0	μA
		$V_{DD} = 15V$		1.0			1.0		30.0	μA
V_{OL}	Low Level Output Voltage	$V_{IN} = V_{DD}, I_O < 1 \mu A$								
		$V_{DD} = 5V$		0.05		0	0.05		0.05	V
		$V_{DD} = 10V$		0.05		0	0.05		0.05	V
		$V_{DD} = 15V$		0.05		0	0.05		0.05	V
V_{OH}	High Level Output Voltage	$V_{IN} = V_{SS}, I_O < 1 \mu A$								
		$V_{DD} = 5V$	4.95		4.95	5		4.95		V
		$V_{DD} = 10V$	9.95		9.95	10		9.95		V
		$V_{DD} = 15V$	14.95		14.95	15		14.95		V
V_{T^-}	Negative-Going Threshold Voltage (Any Input)	$ I_O < 1 \mu A$								
		$V_{DD} = 5V, V_O = 4.5V$	1.3	2.25	1.5	1.8	2.25	1.5	2.3	V
		$V_{DD} = 10V, V_O = 9V$	2.85	4.5	3.0	4.1	4.5	3.0	4.65	V
V_{T^+}	Positive-Going Threshold Voltage (Any Input)	$ I_O < 1 \mu A$								
		$V_{DD} = 5V, V_O = 0.5V$	2.75	3.65	2.75	3.3	3.5	2.65	3.5	V
		$V_{DD} = 10V, V_O = 1V$	5.5	7.15	5.5	6.2	7.0	5.35	7.0	V
V_H	Hysteresis ($V_{T^+} - V_{T^-}$) (Any Input)	$V_{DD} = 5V$	0.5	2.35	0.5	1.5	2.0	0.35	2.0	V
		$V_{DD} = 10V$	1.0	4.30	1.0	2.2	4.0	0.70	4.0	V
		$V_{DD} = 15V$	1.5	6.30	1.5	2.7	6.0	1.20	6.0	V
I_{OL}	Low Level Output Current (Note 3)	$V_{IN} = V_{DD}$								
		$V_{DD} = 5V, V_O = 0.4V$	0.64		0.51	0.88		0.36		mA
		$V_{DD} = 10V, V_O = 0.5V$	1.6		1.3	2.25		0.9		mA
		$V_{DD} = 15V, V_O = 1.5V$	4.2		3.4	8.8		2.4		mA
I_{OH}	High Level Output Current (Note 3)	$V_{IN} = V_{SS}$								
		$V_{DD} = 5V, V_O = 4.6V$	-0.64		0.51	-0.88		-0.36		mA
		$V_{DD} = 10V, V_O = 9.5V$	-1.6		-1.3	-2.25		-0.9		mA
		$V_{DD} = 15V, V_O = 13.5V$	-4.2		-3.4	-8.8		-2.4		mA
I_{IN}	Input Current	$V_{DD} = 15V, V_{IN} = 0V$		-0.1		-10^{-5}	-0.1		-1.0	μA
		$V_{DD} = 15V, V_{IN} = 15V$		0.1		10^{-5}	0.1		1.0	μA

Note 1: "Absolute Maximum Ratings" are those values beyond which the safety of the device cannot be guaranteed; they are not meant to imply that the devices should be operated at these limits. The table of "Recommended Operating Conditions" and "Electrical Characteristics" provides conditions for actual device operation.

Note 2: $V_{SS} = 0V$ unless otherwise specified.

Note 3: I_{OH} and I_{OL} are tested one output at a time.

DC Electrical Characteristics CD4093BC (Note 2)

Symbol	Parameter	Conditions	-40°C		+25°C			+85°C		Units	
			Min	Max	Min	Typ	Max	Min	Max		
I _{DD}	Quiescent Device Current	V _{DD} = 5V		1.0				1.0		7.5	μA
		V _{DD} = 10V		2.0				2.0		15.0	μA
		V _{DD} = 15V		4.0				4.0		30.0	μA
V _{OL}	Low Level Output Voltage	V _{IN} = V _{DD} , I _O < 1 μA									
		V _{DD} = 5V		0.05		0	0.05			0.05	V
		V _{DD} = 10V		0.05		0	0.05			0.05	V
		V _{DD} = 15V		0.05		0	0.05			0.05	V
V _{OH}	High Level Output Voltage	V _{IN} = V _{SS} , I _O < 1 μA									
		V _{DD} = 5V	4.95		4.95	5		4.95			V
		V _{DD} = 10V	9.95		9.95	10		9.95			V
		V _{DD} = 15V	14.95		14.95	15		14.95			V
V _{T⁻}	Negative-Going Threshold Voltage (Any Input)	I _O < 1 μA									
		V _{DD} = 5V, V _O = 4.5V	1.3	2.25	1.5	1.8	2.25	1.5	2.3		V
		V _{DD} = 10V, V _O = 9V	2.85	4.5	3.0	4.1	4.5	3.0	4.65		V
		V _{DD} = 15V, V _O = 13.5V	4.35	6.75	4.5	6.3	6.75	4.5	6.9		V
V _{T⁺}	Positive-Going Threshold Voltage (Any Input)	I _O < 1 μA									
		V _{DD} = 5V, V _O = 0.5V	2.75	3.6	2.75	3.3	3.5	2.65	3.5		V
		V _{DD} = 10V, V _O = 1V	5.5	7.15	5.5	6.2	7.0	5.35	7.0		V
		V _{DD} = 15V, V _O = 1.5V	8.25	10.65	8.25	9.0	10.5	8.1	10.5		V
V _H	Hysteresis (V _{T⁺} - V _{T⁻}) (Any Input)	V _{DD} = 5V	0.5	2.35	0.5	1.5	2.0	0.35	2.0		V
		V _{DD} = 10V	1.0	4.3	1.0	2.2	4.0	0.70	4.0		V
		V _{DD} = 15V	1.5	6.3	1.5	2.7	6.0	1.20	6.0		V
I _{OL}	Low Level Output Current (Note 3)	V _{IN} = V _{DD}									
		V _{DD} = 5V, V _O = 0.4V	0.52		0.44	0.88		0.36			mA
		V _{DD} = 10V, V _O = 0.5V	1.3		1.1	2.25		0.9			mA
		V _{DD} = 15V, V _O = 1.5V	3.6		3.0	8.8		2.4			mA
I _{OH}	High Level Output Current (Note 3)	V _{IN} = V _{SS}									
		V _{DD} = 5V, V _O = 4.6V	-0.52		0.44	-0.88		-0.36			mA
		V _{DD} = 10V, V _O = 9.5V	-1.3		-1.1	-2.25		-0.9			mA
		V _{DD} = 15V, V _O = 13.5V	-3.6		-3.0	-8.8		-2.4			mA
I _{IN}	Input Current	V _{DD} = 15V, V _{IN} = 0V		-0.3		-10 ⁻⁵	-0.3		-1.0		μA
		V _{DD} = 15V, V _{IN} = 15V		0.3		10 ⁻⁵	0.3		1.0		μA

AC Electrical Characteristics*

T_A = 25°C, C_L = 50 pF, R_L = 200k, Input t_r, t_f = 20 ns, unless otherwise specified

Symbol	Parameter	Conditions	Min	Typ	Max	Units
t _{PHL} , t _{PLH}	Propagation Delay Time	V _{DD} = 5V		300	450	ns
		V _{DD} = 10V		120	210	ns
		V _{DD} = 15V		80	160	ns
t _{THL} , t _{TLH}	Transition Time	V _{DD} = 5V		90	145	ns
		V _{DD} = 10V		50	75	ns
		V _{DD} = 15V		40	60	ns
C _{IN}	Input Capacitance	(Any Input)		5.0	7.5	pF
C _{PD}	Power Dissipation Capacitance	(Per Gate)		24		pF

*AC Parameters are guaranteed by DC correlated testing.

Note 2: V_{SS} = 0V unless otherwise specified.

Note 3: I_{OH} and I_{OL} are tested one output at a time.

Typical Applications

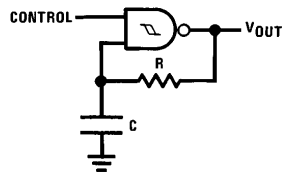

Assume $t_1 + t_2 \gg t_{pHL} + t_{pLH}$ then:

$$t_0 = RC \ln [V_{DD}/V_{T-}]$$

$$t_1 = RC \ln [(V_{DD} - V_{T-})/(V_{DD} - V_{T+})]$$

$$t_2 = RC \ln [V_{T+}/V_{T-}]$$

$$f = \frac{1}{t_1 + t_2} = \frac{1}{RC \ln \frac{(V_{T+})(V_{DD} - V_{T-})}{(V_{T-})(V_{DD} - V_{T+})}}$$

Gated Oscillator

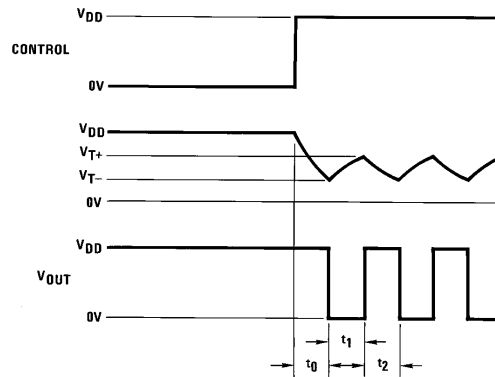

TL/F/5982-2

TL/F/5982-3

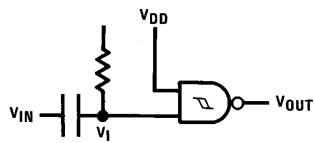

TL/F/5982-4

Gated One-Shot

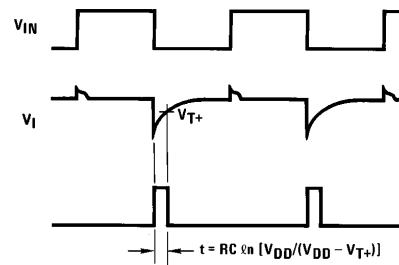

TL/F/5982-5

(a) Negative-Edge Triggered

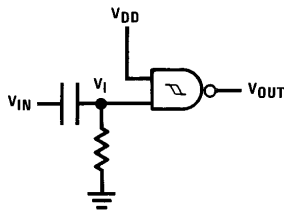

TL/F/5982-6

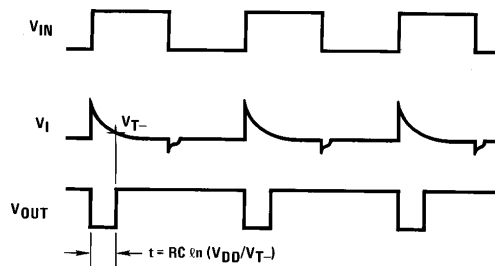

TL/F/5982-7

(b) Positive-Edge Triggered

Typical Performance Characteristics

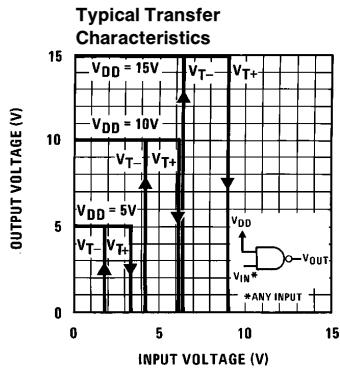

TL/F/5982-8

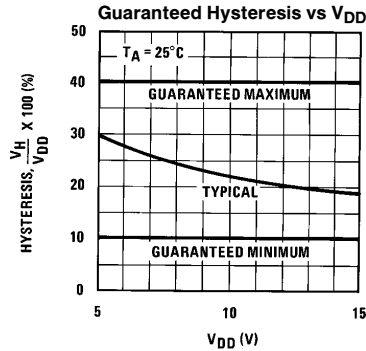

TL/F/5982-9

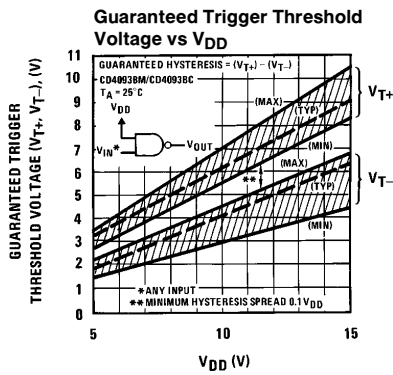

TL/F/5982-10

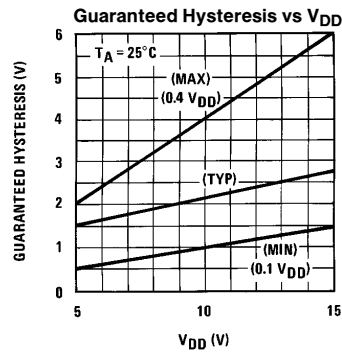

TL/F/5982-11

Input and Output Characteristics

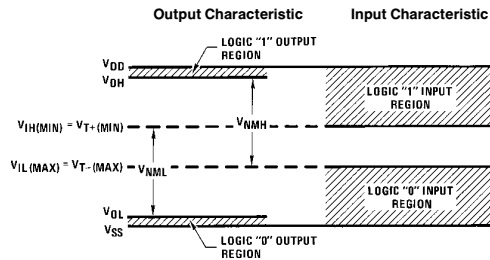
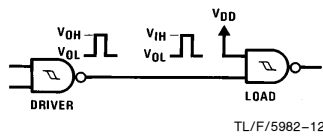

TL/F/5982-13

$$V_{NML} = V_{IH(MIN)} - V_{OL} \approx V_{IH(MIN)} = V_{T+ (MIN)}$$

$$V_{NMH} = V_{OH} - V_{IL(MAX)} \approx V_{DD} - V_{IL(MAX)} = V_{DD} - V_{T- (MAX)}$$

AC Test Circuits and Switching Time Waveforms

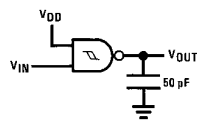

TL/F/5982-14

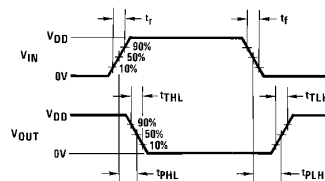

TL/F/5982-15

Physical Dimensions inches (millimeters)

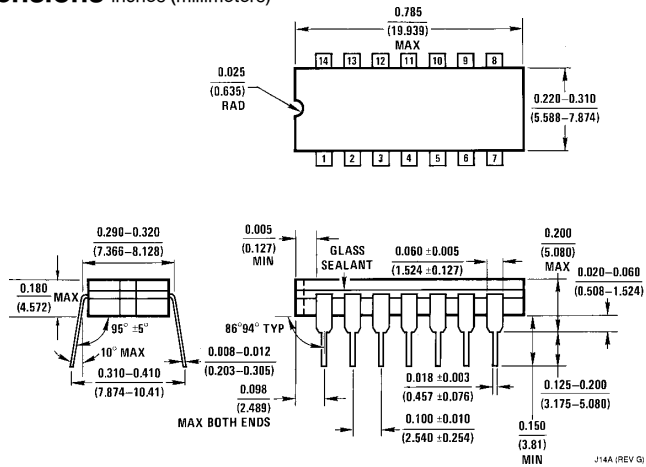

Ceramic Dual-In-Line Package (J)
Order Number CD4093BMJ or CD4093BCJ
NS Package Number J14A

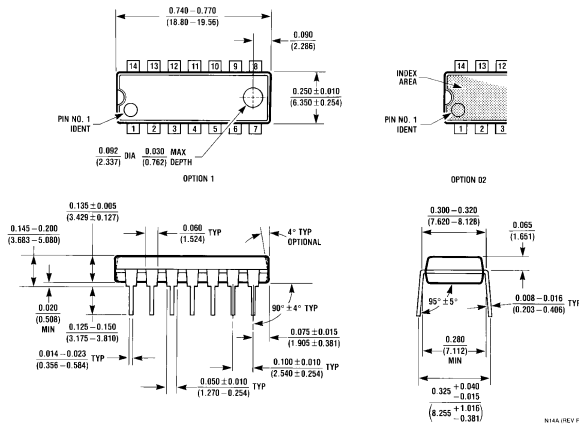

Molded Dual-In-Line Package (N)
Order Number CD4093BM or CD4093BCN
NS Package Number N14A

LIFE SUPPORT POLICY

NATIONAL'S PRODUCTS ARE NOT AUTHORIZED FOR USE AS CRITICAL COMPONENTS IN LIFE SUPPORT DEVICES OR SYSTEMS WITHOUT THE EXPRESS WRITTEN APPROVAL OF THE PRESIDENT OF NATIONAL SEMICONDUCTOR CORPORATION. As used herein:

1. Life support devices or systems are devices or systems which, (a) are intended for surgical implant into the body, or (b) support or sustain life, and whose failure to perform, when properly used in accordance with instructions for use provided in the labeling, can be reasonably expected to result in a significant injury to the user.
2. A critical component is any component of a life support device or system whose failure to perform can be reasonably expected to cause the failure of the life support device or system, or to affect its safety or effectiveness.



National Semiconductor Corporation
 1111 West Bardin Road
 Arlington, TX 76017
 Tel: 1(800) 272-9959
 Fax: 1(800) 737-7018

National Semiconductor Europe
 Fax: (+49) 0-180-530 85 86
 Email: cnjwge@tevm2.nsc.com
 Deutsch Tel: (+49) 0-180-530 85 85
 English Tel: (+49) 0-180-532 78 32
 Français Tel: (+49) 0-180-532 93 58
 Italiano Tel: (+49) 0-180-534 16 80

National Semiconductor Hong Kong Ltd.
 19th Floor, Straight Block,
 Ocean Centre, 5 Canton Rd.
 Tsimshatsui, Kowloon
 Hong Kong
 Tel: (852) 2737-1600
 Fax: (852) 2736-9960

National Semiconductor Japan Ltd.
 Tel: 81-043-299-2309
 Fax: 81-043-299-2408

National does not assume any responsibility for use of any circuitry described, no circuit patent licenses are implied and National reserves the right at any time without notice to change said circuitry and specifications.