

2SC4004

Silicon NPN triple diffusion planar type

For high breakdown voltage high-speed switching

Features

- High-speed switching
- High collector to base voltage V_{CBO}
- Wide area of safe operation (ASO)
- Satisfactory linearity of forward current transfer ratio h_{FE}
- Full-pack package which can be installed to the heat sink with one screw

Absolute Maximum Ratings ($T_C=25^\circ\text{C}$)

Parameter	Symbol	Rated	Unit	
Collector to base voltage	V_{CBO}	900	V	
Collector to emitter voltage	V_{CES}	900	V	
	V_{CEO}	800	V	
Emitter to base voltage	V_{EBO}	7	V	
Peak collector current	I_{CP}	2	A	
Collector current	I_C	1	A	
Base current	I_B	0.3	A	
Collector power dissipation	P_C	$T_C=25^\circ\text{C}$	30	W
		$T_a=25^\circ\text{C}$	2	
Junction temperature	T_j	150	$^\circ\text{C}$	
Storage temperature	T_{stg}	-55 to +150	$^\circ\text{C}$	

Electrical Characteristics ($T_C=25^\circ\text{C}$)

Parameter	Symbol	Conditions	min	typ	max	Unit
Collector cutoff current	I_{CBO}	$V_{CB} = 900\text{V}, I_E = 0$			50	μA
Emitter cutoff current	I_{EBO}	$V_{EB} = 7\text{V}, I_C = 0$			50	μA
Collector to emitter voltage	V_{CEO}	$I_C = 1\text{mA}, I_B = 0$	800			V
Forward current transfer ratio	h_{FE1}	$V_{CE} = 5\text{V}, I_C = 0.05\text{A}$	6			
	h_{FE2}	$V_{CE} = 5\text{V}, I_C = 0.5\text{A}$	3			
Collector to emitter saturation voltage	$V_{CE(sat)}$	$I_C = 0.2\text{A}, I_B = 0.04\text{A}$			1.5	V
Base to emitter saturation voltage	$V_{BE(sat)}$	$I_C = 0.2\text{A}, I_B = 0.04\text{A}$			1.0	V
Transition frequency	f_T	$V_{CE} = 10\text{V}, I_C = 0.05\text{A}, f = 1\text{MHz}$		4		MHz
Turn-on time	t_{on}	$I_C = 0.2\text{A}, I_{B1} = 0.04\text{A}, I_{B2} = -0.04\text{A}, V_{CC} = 250\text{V}$			1.0	μs
Storage time	t_{stg}				3.0	μs
Fall time	t_f				1.0	μs

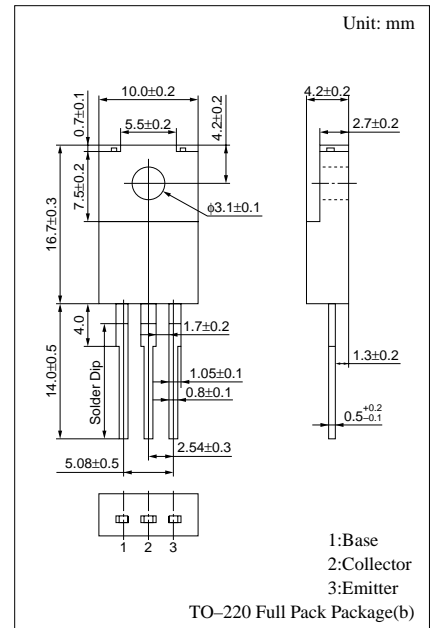

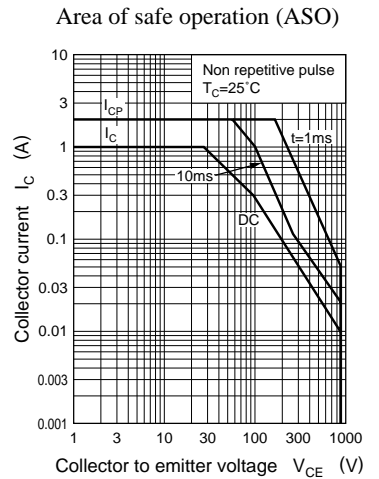
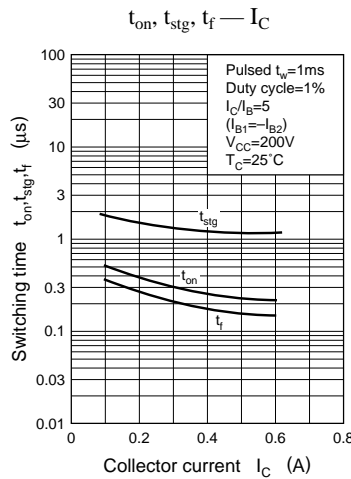
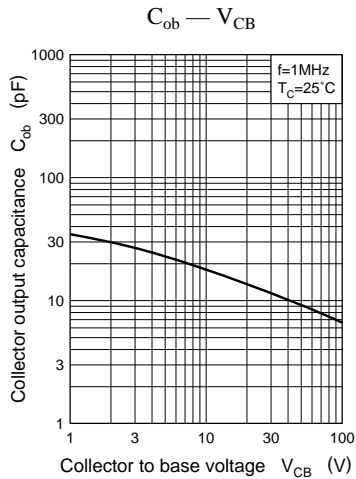
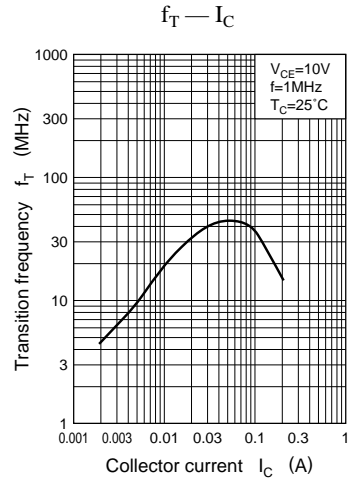
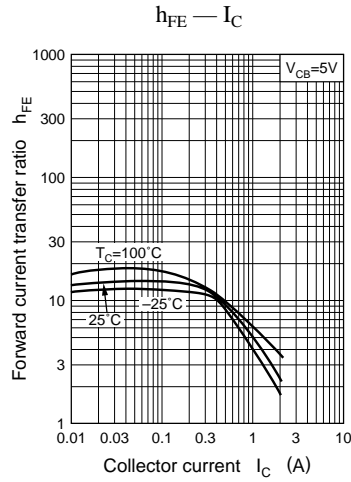
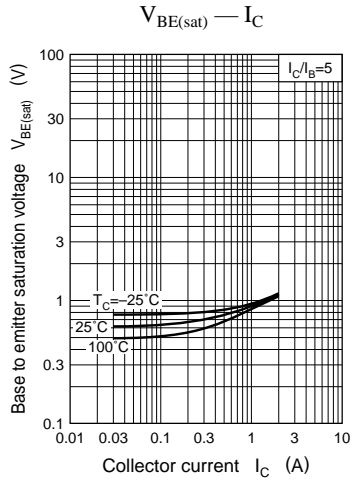
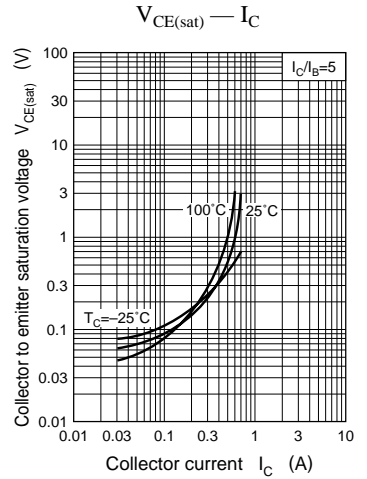
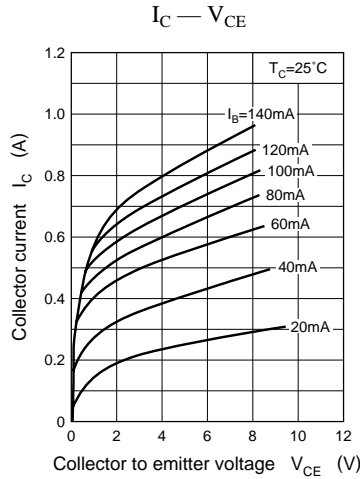
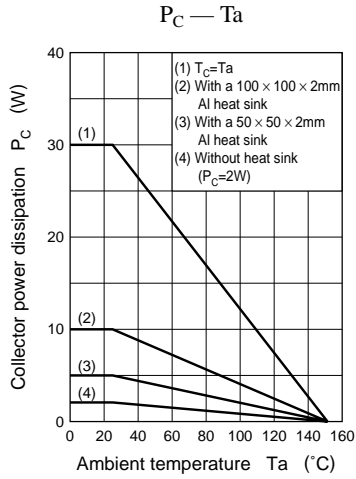

Area of safe operation, reverse bias ASO

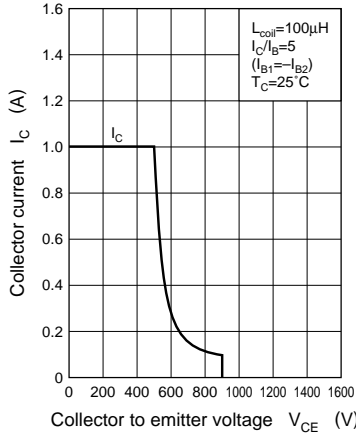

Reverse bias ASO measuring circuit

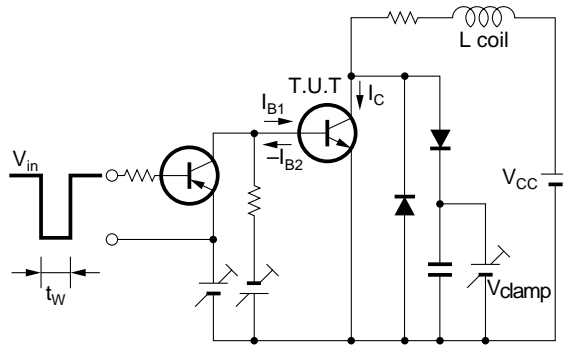

$R_{th(t)} - t$

