

LM382 Low Noise Dual Preamplifier

General Description

The LM382 is a dual preamplifier for the amplification of low level signals in applications requiring optimum noise performance. Each of the two amplifiers is completely independent, with individual internal power supply decoupler-regulator, providing 120 dB supply rejection and 60 dB channel separation. Other outstanding features include high gain (100 dB), and wide power bandwidth (75 kHz, 20 Vp-p). The LM382 operates from a single supply across the wide range of 9V to 40V.

A resistor matrix is provided on the chip to allow the user to select a variety of closed loop gain options and frequency response characteristics such as flat-band, NAB or RIAA equalization. The circuit is supplied in the 14 lead dual-in-line package.

Features

- Low noise — 0.8 μV total equivalent input noise
- High gain — 100 dB open loop
- Single supply operation
- Wide supply range 9V to 40V
- Power supply rejection — 120 dB
- Large output voltage swing
- Wide bandwidth — 15 MHz unity gain
- Power bandwidth — 75 kHz, 20 Vp-p
- Internally compensated
- Short circuit protected

Schematic and Connection Diagrams

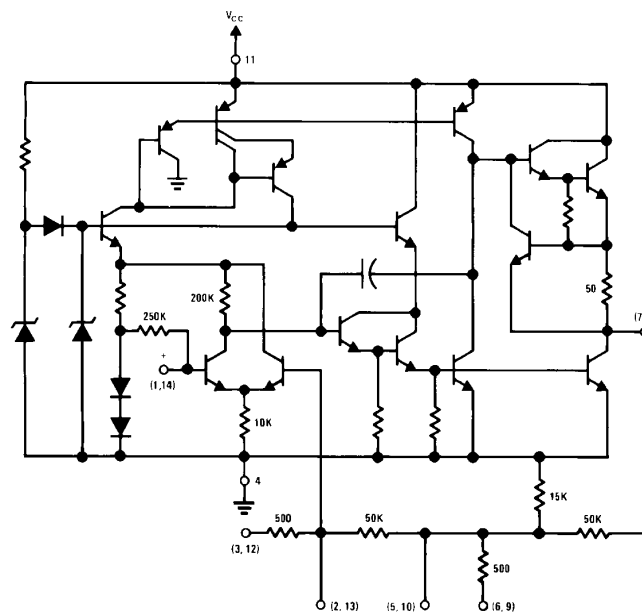

TL/H/7842-1

Dual-In-Line Package

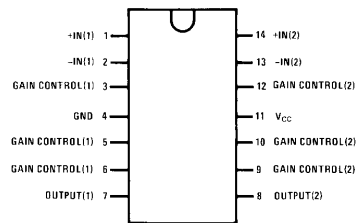

TL/H/7842-2

Top View

Order Number LM382N
See NS Package Number N14A

Absolute Maximum Ratings

If Military/Aerospace specified devices are required, please contact the National Semiconductor Sales Office/Distributors for availability and specifications.

Supply Voltage +40V
Power Dissipation (Note 1) 1.56 W

Operating Temperature Range 0°C to +70°C
Storage Temperature Range -65°C to +150°C
Lead Temperature (Soldering, 10 sec.) +260°C

Electrical Characteristics $T_A = 25^\circ\text{C}$, $V_{CC} = 14\text{V}$, unless otherwise stated.

Parameter	Conditions	Min	Typ	Max	Units
Voltage Gain	Open Loop, $f = 100\text{ Hz}$		100,000		V/V
Supply Current	$V_{CC} 9\text{V to }40\text{V}$, $R_L = \infty$		10	20	mA
Output DC Voltage			6		V
Input Resistance (Positive Input) (Negative Input)			100		k Ω
			200		k Ω
Input Current (Negative Input)			0.5		μA
Output Resistance	Open Loop		150		Ω
Output Current	Source		8		mA
	Sink		2		mA
Output Voltage Swing	Peak-to-Peak, $R_L = 10\text{k}$		12		V
Unity Gain Bandwidth			15		MHz
Power Bandwidth	20 Vp-p ($V_{CC} = 24\text{V}$)		75		kHz
Maximum Input Voltage	Linear Operation			300	mVrms
Supply Rejection Ratio	$f = 1\text{ kHz}$		120		dB
Channel Separation	$f = 1\text{ kHz}$	40	60		dB
Total Harmonic Distortion	60 dB Gain, $f = 1\text{ kHz}$		0.1	0.3	%
Total Equivalent Input Noise	$R_S = 600\Omega$, 100-10,000 Hz (Flat Response Circuit)		0.8	1.2	μVrms

Note 1: For operation in ambient temperatures above 25°C, the device must be derated based on a 150°C maximum junction temperature and a thermal resistance of 80°C/W junction to ambient.

Typical Applications

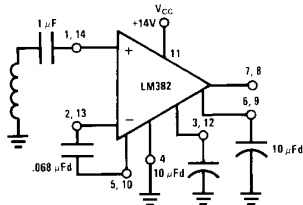

TL/H/7842-3

Tape Preamp (NAB Equalization)

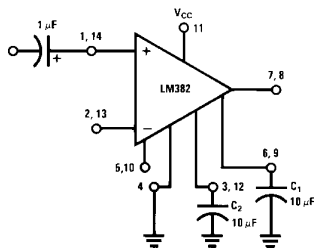

TL/H/7842-5

Flat Response — Fixed Gain Configuration

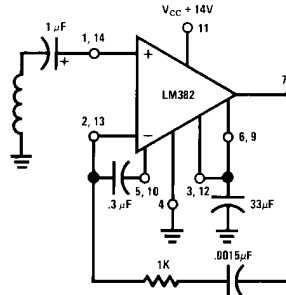

TL/H/7842-4

Phono Preamp (RIAA Equalization)

Capacitor	Gain
C1 Only	40 dB
C2 Only	55 dB
C1 & C2	80 dB

Typical Performance Characteristics

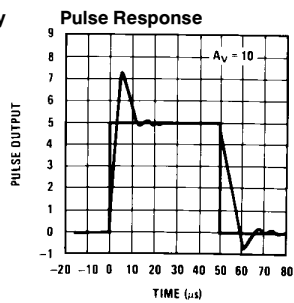
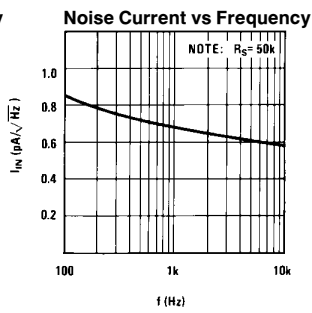
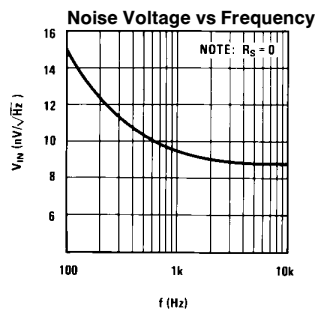
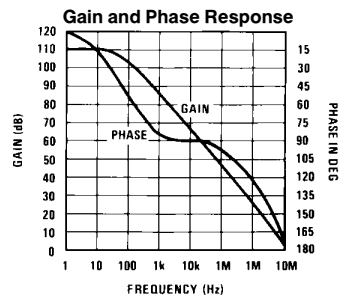
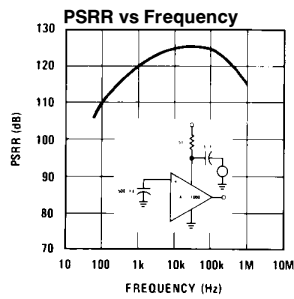
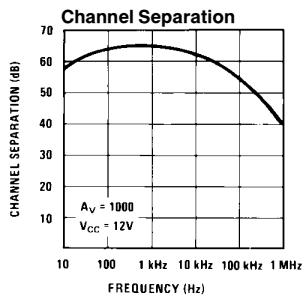
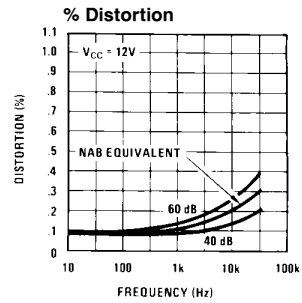
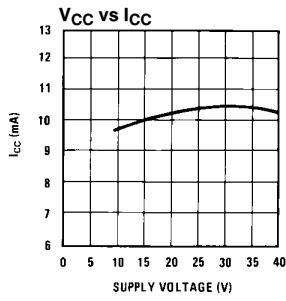
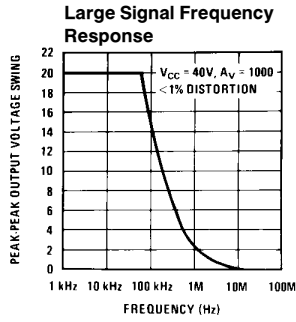

TL/H/7842-6

Physical Dimensions inches (millimeters)

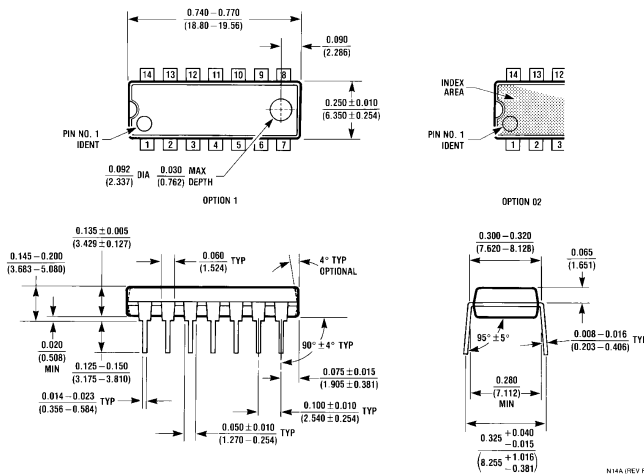

Molded Dual-In-Line Package (N)
Order Number LM382N
NS Package Number N14A

LIFE SUPPORT POLICY

NATIONAL'S PRODUCTS ARE NOT AUTHORIZED FOR USE AS CRITICAL COMPONENTS IN LIFE SUPPORT DEVICES OR SYSTEMS WITHOUT THE EXPRESS WRITTEN APPROVAL OF THE PRESIDENT OF NATIONAL SEMICONDUCTOR CORPORATION. As used herein:

1. Life support devices or systems are devices or systems which, (a) are intended for surgical implant into the body, or (b) support or sustain life, and whose failure to perform, when properly used in accordance with instructions for use provided in the labeling, can be reasonably expected to result in a significant injury to the user.
2. A critical component is any component of a life support device or system whose failure to perform can be reasonably expected to cause the failure of the life support device or system, or to affect its safety or effectiveness.



National Semiconductor Corporation
 1111 West Bardin Road
 Arlington, TX 76017
 Tel: 1(800) 272-9959
 Fax: 1(800) 737-7018

National Semiconductor Europe
 Fax: (+49) 0-180-530 85 86
 Email: cnjwge@tevm2.nsc.com
 Deutsch Tel: (+49) 0-180-530 85 85
 English Tel: (+49) 0-180-532 78 32
 Français Tel: (+49) 0-180-532 93 58
 Italiano Tel: (+49) 0-180-534 16 80

National Semiconductor Hong Kong Ltd.
 19th Floor, Straight Block,
 Ocean Centre, 5 Canton Rd.
 Tsimshatsui, Kowloon
 Hong Kong
 Tel: (852) 2737-1600
 Fax: (852) 2736-9960

National Semiconductor Japan Ltd.
 Tel: 81-043-299-2309
 Fax: 81-043-299-2408

National does not assume any responsibility for use of any circuitry described, no circuit patent licenses are implied and National reserves the right at any time without notice to change said circuitry and specifications.