

T-4(-90)

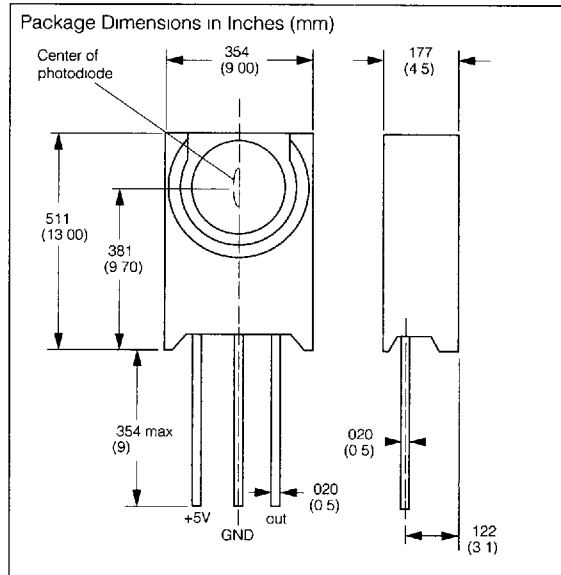
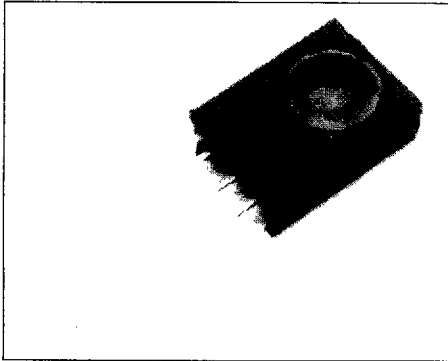

FEATURES

- Photodiode with Hybrid Integrated Circuit
- 30 kHz Carrier Frequency
- Black Epoxy Package with Daylight Filter Optimized for 950 nm
- High Immunity Against Ambient Light
- Low Power Consumption
- 5 V Supply Voltage
- High Sensitivity
- Internal EMI/RFI Shield

DESCRIPTION

The SFH505A incorporates a silicon PIN photodiode, IR detector IC, and demodulator in a lensed and filtered plastic housing. The device is compact, rugged and has a high immunity to ambient light and RFI/EMI interference because of its internal shielding.

Applications include remote control with televisions, video games, garage door openers, electronic toys, and automobiles.

Maximum Ratings

Operating/Storage Temperature (T _{OP} , T _{STG}) -25° to +85°C
Soldering Temperature (≥2 mm from case) (T _S) t ≤ 3 s 260°C
Supply Voltage (V _{CC}) -0.3 to +7.0V
Output Voltage (V _O) -0.3 to +7.0V
Output Current (I _O) 3 mA

Characteristics (T_A=25°C)

Parameter	Symbol	Value	Unit
Operating Voltage Range	V _{CC}	4.5 to 5.5	V
Operating Temperature Range	T _A	0 to 70°	°C
Switching Threshold (950 nm, f=30 kHz)	E _{ES} ⁽¹⁾	40	nW/cm ²
Wavelength, Maximum Sensitivity	λ _{Smax}	950	nm
Spectral Sensitivity Range (S=10% of S _{MAX})	Δλ	±160	nm
Half Angle	φ	±50	Deg
Current Consumption	I _{CC}	0.65	mA
Output Voltage (I _O =100 μA)	V _{Olow}	<0.4	V
Output (output high, V _O =5 V)	I _O	<10	μA
Turn-on Time ⁽²⁾ (E _E =250 nW/cm ² , f=30 kHz)	t _{ON}	100	μs
Turn-off Time ⁽²⁾ (E _E =250 nW/cm ² , f=30 kHz)	t _{OFF}	200	μs
Conducting Time (E _E =200 μW/cm ² , f=30 kHz)	t _{LOW}	700	μs
(E _E =250 μW/cm ² , f=30 kHz)	t _{LOW}	500	μs

Notes 1. A 30 m transmission distance is possible when used with IR emitter SFH415 at I_F=1 A (I_E=400 mW/sr)
2. See Figure 2

Photodiodes

SIEMENS AKTIENGESELLSCHAFT

Figure 1. External Circuit

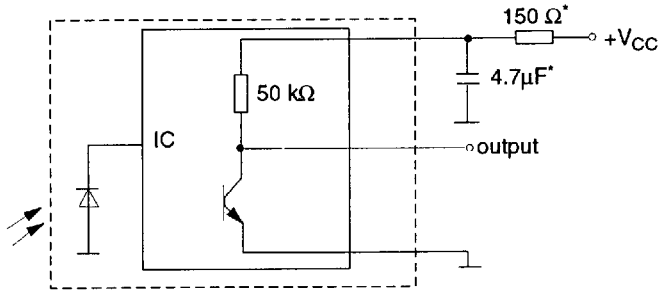

* Blocking devices if required

Figure 2. Timing Diagram

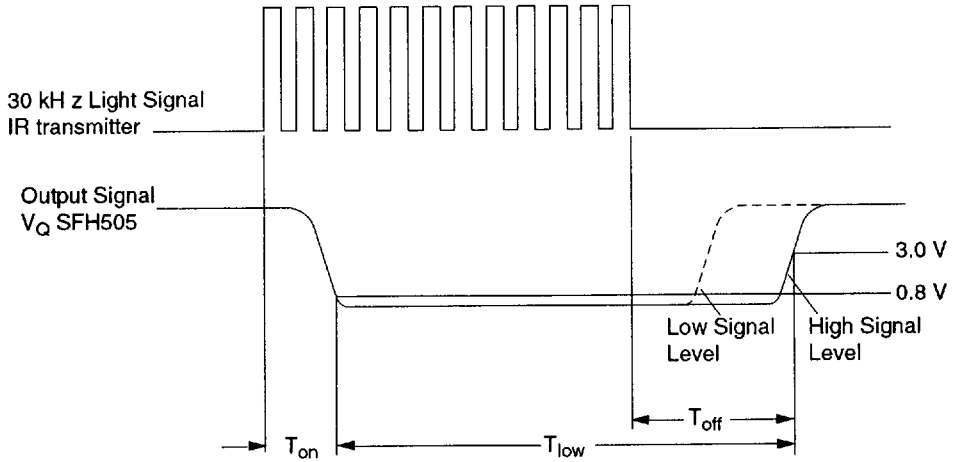

SIEMENS AKTIENGESELLSCHAFT

Directional characteristics

$S_{REL} = f(\rho)$

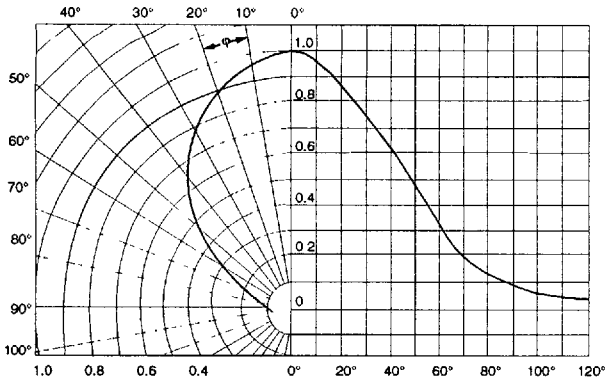

Current consumption

$I_{CC1} = f(V_{CC})$

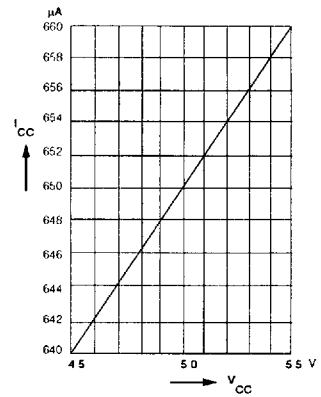

Switching threshold

$E_{ES} = f(T_A)$

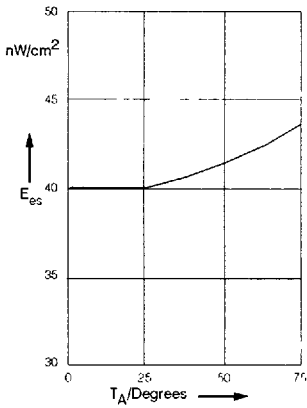

Turn-on time $t_{ON} = f(E_E)$

$f = 30 \text{ kHz}, 12 \text{ pulses}$

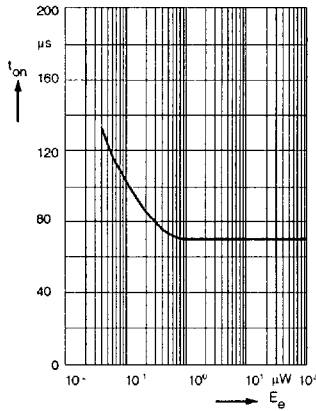

Turn-off time $t_{OFF} = f(E_E)$

$f = 30 \text{ kHz}, 12 \text{ pulses}$

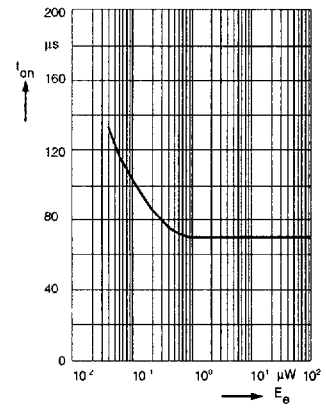

Extraneous light effect to switching threshold

$E_{ES} = f(E_V)$

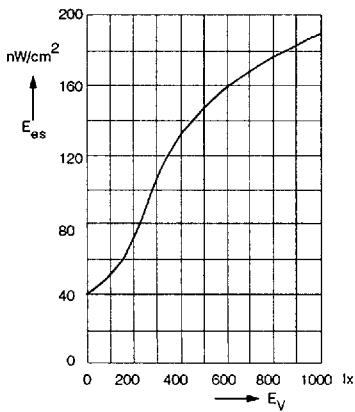

Relative spectral sensitivity

$i = f(\nu)$

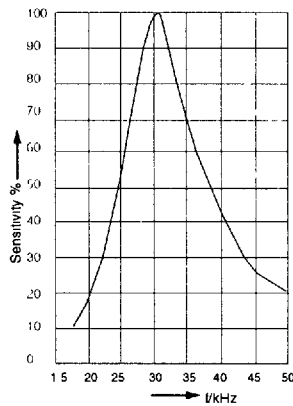

Photodiodes

This datasheet has been downloaded from:

www.DatasheetCatalog.com

Datasheets for electronic components.