

P R O D U C T G U I D E

SOFT FERRITE CORES



Mahindra *CIE*

Mahindra CIE Automotive Limited
Magnetic Product Division (MPD)

About Mahindra CIE Automotive

Mahindra CIE Automotive Limited is the listed entity which operates as a single company having 6 business lines. In 2013, the Mahindra Group announced its global alliance with CIE Automotive of Spain with intent of creating an automotive supplier that would rank amongst the Top 100 globally.

Mahindra CIE Automotive, combined the Mahindra Group's automotive component operations held under the Systech Sector with CIE Automotive's European Forgings Operations.

The Systech automotive component business covered a product portfolio spanning stampings, castings, forgings, gears, magnetic Products and composites with operations in India, Germany, Italy and the UK. CIE's European forging business has operations in Spain and Lithuania.

About Magnetic Product Division

Mahindra CIE (MPD) - The pioneers and leaders

MPD pioneers the ferrite manufacturing process in India four decades ago and has continuously kept pace with the changing needs of the industry. Today as the largest manufacturer of ferrite, we offer the widest range of Hard & Soft ferrite products in the Indian sub-continent.

Leadership Through Quality An TS16949:2009 Company

Ferrite manufacturing is highly technology intensive and involves in diverse fields like chemical, ceramic, metallurgical, mechanical, electrical & electronics engineering. Quality at our company is the outcome of continuous team effort backed by years of experience and expertise in ferrite technology, supported by the best of plant and equipment. Our quality management systems have been certified to conform to TS 16949:2009 standard. After all, most of the electronics & automotive giants in India depend on us for international quality ferrites. Mahindra CIE - MPD has been certified under BS OHSAS 18001:2007 and ISO 14001:2004. MPD has in place an Occupational Health, Safety, and Environmental Management System. It demonstrates MPD's responsibility and commitment to environmental-friendly business practices, with minimal or no impact on the environment.

A wide range of Soft & Hard Ferrites from a single reliable source.

We are fully geared to meet the ever changing and exacting demands of the rapidly growing electronics industry. The component industry traditionally being amongst the most competitive, our efforts are towards working with customers to develop new products and materials as well as improve process capability substantially, adding value to the customers. This product guide is intended to familiarise you with our range of products and help you choose the one best suited to your requirements. Of course we also would welcome your suggestion / feedback which would guide our development efforts for the future.

Mahindra CIE



- Material Grades
- Material Characteristics Graphs
- Cross Reference Table
- EE Cores
- EER , EEC , ETD Cores
- EI Cores
- EFD Cores
- EP Cores
- EPC and FQKT Cores
- PQ Cores
- RM Cores
- ESQ and USQ Cores
- Planar Cores
- UU and UI Cores
- Colur FBT Core
- Ferrite Bars
- Torroids
- Drum Cores
- Small rods

Ferrites are magnetic ceramic materials composed of metal oxides with Iron oxide as their main constituent. Ferrites have now been firmly established as one of the most important class of magnetic materials and are indispensable in Electrical, Electronics and Communication Engineering. Ferrites which exhibit temporary magnetic properties under the influence of an electrical field are called Soft Ferrites. Soft Ferrites allow easy magnetisation and also rapid reversal of the magnetisation in response to rapid alteration of energising field.

MnZn Ferrite Material Characteristics

Property	Symbol	Unit	Test condition	MSB-7C	HP400	HP-380	HP-300	HPT-450	HPT-400	HB-040	HM-030	HM-040	HM-045	GQ5C	HM-060	HM-070	HM-100**	HT-08	HT-020	HT-35	HR-4	HR-4B	HQ-023		
Initial permeability (±25%)	μ_i	---	0.1mT, 25°C	2400	2200	2200	2200	2400	3000	3800	3000	4000	4500	5000	6000	7000	10000	800	2000	3400	1200	2000	2300		
Flux density (min)	Bs	mT	1200A/m, 25°C	500	500	490	510	510	500	550	480	470	470	450	400	400	430	430	470	510	440	500	420		
			1200A/m, 100°C	380	400	390	420	410	390	435	330	330	330	300	240	240	240	320	330	390	350	400	290		
Relative loss factor (max)	$\tan\delta/\mu_i$	10^{-6}	0.25mT, 10kHz, 25°C	2	8	2	3		2		3	3	3	3	5	5	3	10	6	3	4	3	4		
Relative loss factor (max)			0.25mT, 100kHz, 25°C	5	3	3	4		3	4	6	10	10	15	40	60	20	10	10	10	4	5	6		
Coercive Field (max)	Hc	A/m	10kHz, 25°C	10	4	11	11	8	10	15	15	3	3	3	5	4	4	20	14	10	10	10	25		
Hysteris material Coefficient (max)	η_h	$10^{-6}/mT$	25°C	1.2	1.2	1	1	1.1	1.2	0.3	0.3	0.8	1	0.8	0.6	0.5	0.2		2	1	-1	1.34			
Curie Temperature (min)	Tc	°C	----	220	210	210	210	200	220	205	180	170	170	140	130	120	120	190	170	200	240	210	170		
Density (min)	d	kg/m ³	25°C	4800	4850	4850	4850	4850	4800	4900	4900	4900	4900	4900	4900	4900	4900	4850	4850	4800	4800	4800	4700		
Temperature Coeff. of permeability (max)	α_μ	$10^{-6}/K$	-40 to 80°C	4	4	4	4	2.5	1.5	1.2	1.2	3	2.5	3	2	2	2	±3	±0.4	2	8	13	3		
Resistivity (min)	ρ	Ωm	25°C	5	5	5	8	3	7	2	1	1	1	1	0.6	0.5	0.5	10	1	1	4	4			
Power loss (max)	Pc	mW/cc	16kHz, 150mT, 100°C	40																					
			100kHz, 200mT, 25°C					500	400																
			100kHz, 200mT, 100°C	600	400	380	300	450	400																
			400kHz, 200mT, 25°C																				10000	8000	
			400kHz, 200mT, 100°C																				7000	6000	
Application				Power transformers grades							Communication (Broad band filters)							RFID Antenna		Impeder cores		Inductors			
Properties are measured on Toroid T 30 X 20 X10 mm. Properties on actual product may vary depends on its size and shape. ** Properties are measured on Toroid T 10 X 04 X06 mm. Properties on actual product may vary depends on its size and shape.																									

MSB-7C : POWER TRANSFORMER GRADE

Properties	Symbol	Unit	Test condition	Values
Initial permeability ($\pm 25\%$)	μ_i		0.1mT, 25°C	2400
Flux density (min)	Bs	mT	1200A/m, 25°C	500
			1200A/m, 100°C	380
Coercive Field (max)	Hc	A/m	10KHz, 25°C	10
Hysteris material Coefficient (max)	η_B	$10^{-6}/mT$	25°C	1.2
Curie Temperature (min)	Tc	°C		220
Density (min)	d	kg/m ³	25°C	4800
Temperature Coeff. of permeability (max)	α_F	$10^{-6}/K$	-40 to 80°C	4
Resisitivity (min)	ρ	Ωm	25°C	5
Powerloss (max)	Pc	mW/cc	100kHz, 200mT, 100°C	600

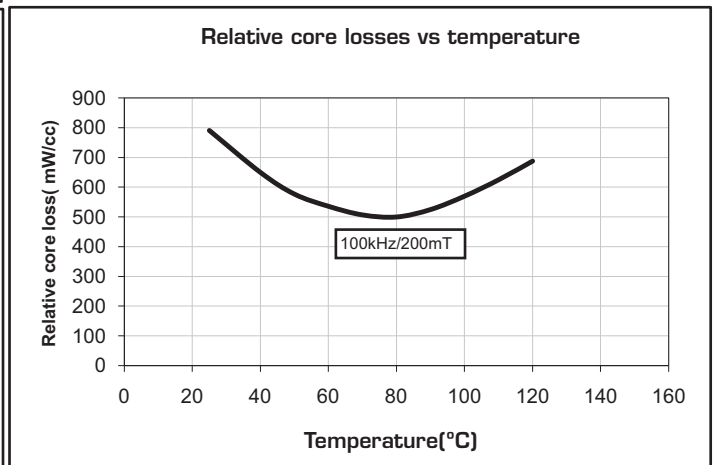
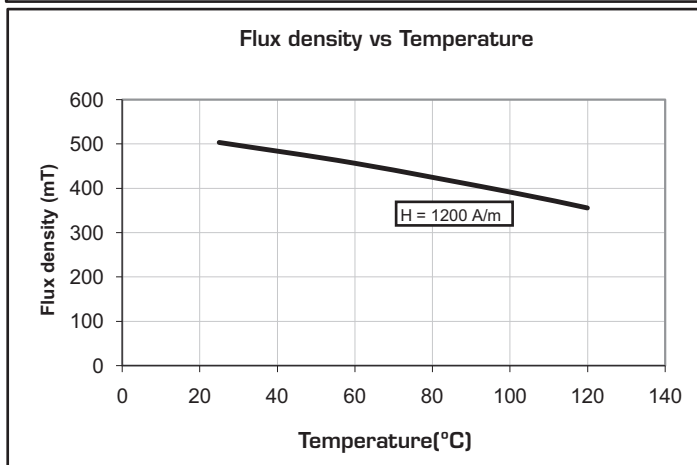
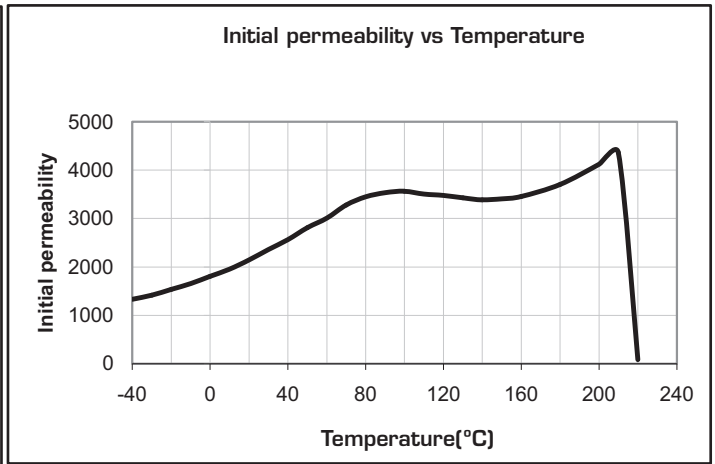
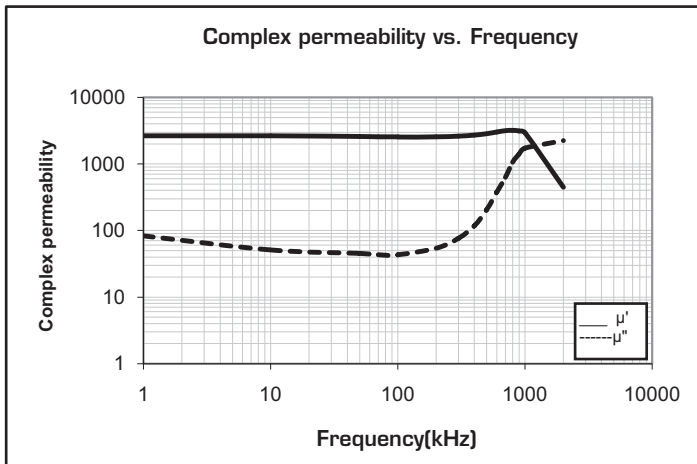

All measurements made on Toroid OD = 30mm, ID=20mm Ht=10mm.

HP-400 : POWER TRANSFORMER GRADE

Properties	Symbol	Unit	Test condition	Values
Initial permeability (±25%)	μ_i		0.1mT, 25°C	2200
Flux density (min)	B_s	mT	1200A/m, 25°C	500
			1200A/m, 100°C	400
Coercive Field (max)	H_c	A/m	10kHz, 25°C	11
Hysteris material Coefficient (max)	η_B	$10^{-6}/mT$	25°C	1.2
Curie Temperature (min)	T_c	°C		210
Density (min)	d	kg/m^3	25°C	4850
Temperature Coeff. of permeability (max)	α_F	$10^{-6}/K$	-40 to 80°C	4
Resisitivity (min)	ρ	Ωm	25°C	5
Powerloss (max)	P_c	mW/cc	100kHz, 200mT, 100°C	400

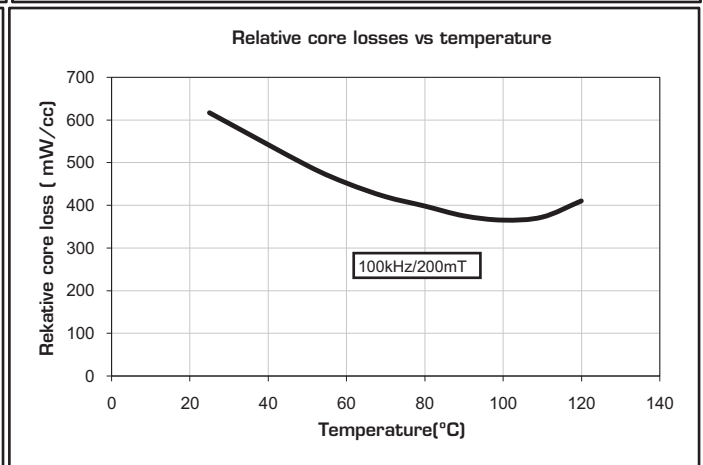
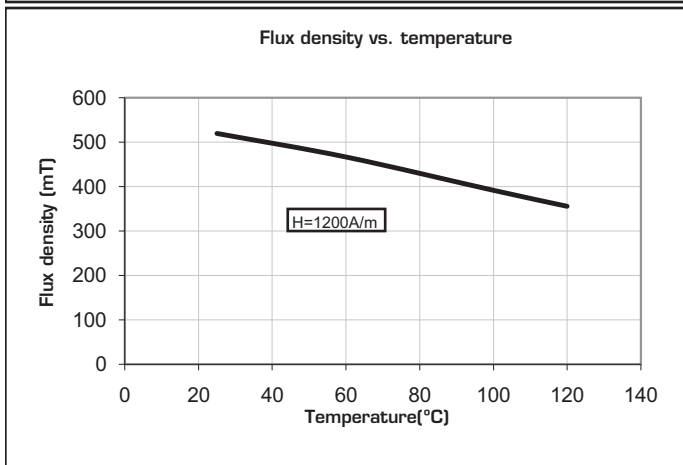
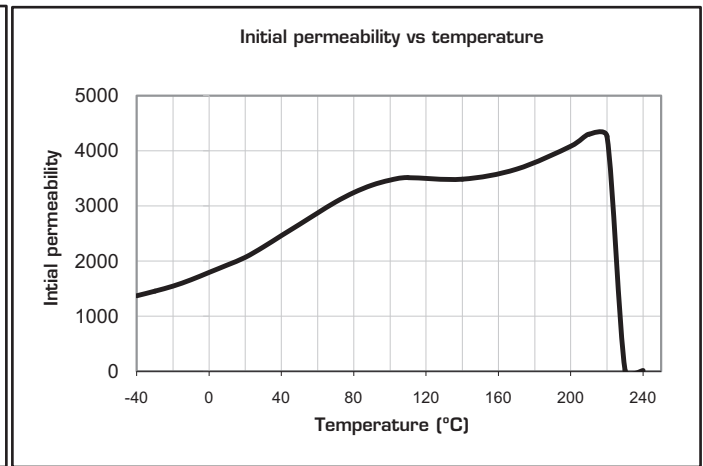
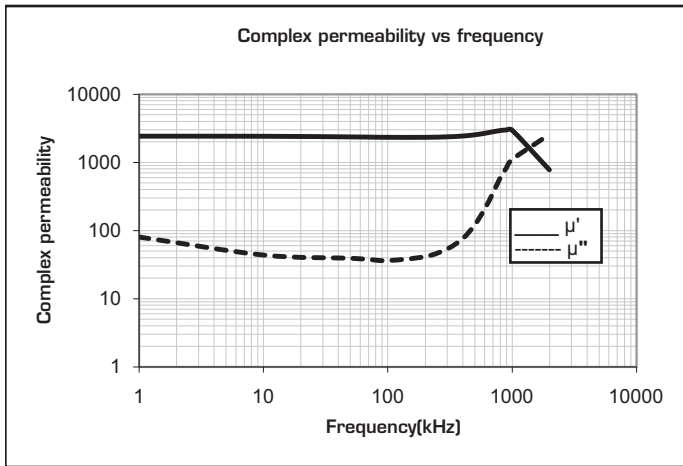

All measurements made on Toroid OD= 30mm, ID=20mm Ht=10mm.

HP-380 : Power Transformer Grade

Properties	Symbol	Unit	Test condition	Values
Initial permeability ($\pm 25\%$)	μ_i		0.1mT, 25°C	2200
Flux density (min)	Bs	mT	1200A/m, 25°C	490
			1200A/m, 100°C	390
Coercive Field (max)	Hc	A/m	10kHz, 25°C	11
Hysteris material Coefficient (max)	η_B	$10^{-6}/mT$	25°C	1
Curie Temperature (min)	Tc	°C		210
Density (min)	d	kg/m ³	25°C	4850
Temperature Coeff. of permeability (max)	α_F	$10^{-6}/K$	-40 to 80°C	4
Resisitivity (min)	ρ	Ωm	25°C	5
Powerloss (max)	Pc	mW/cc	100kHz, 200mT, 100°C	380

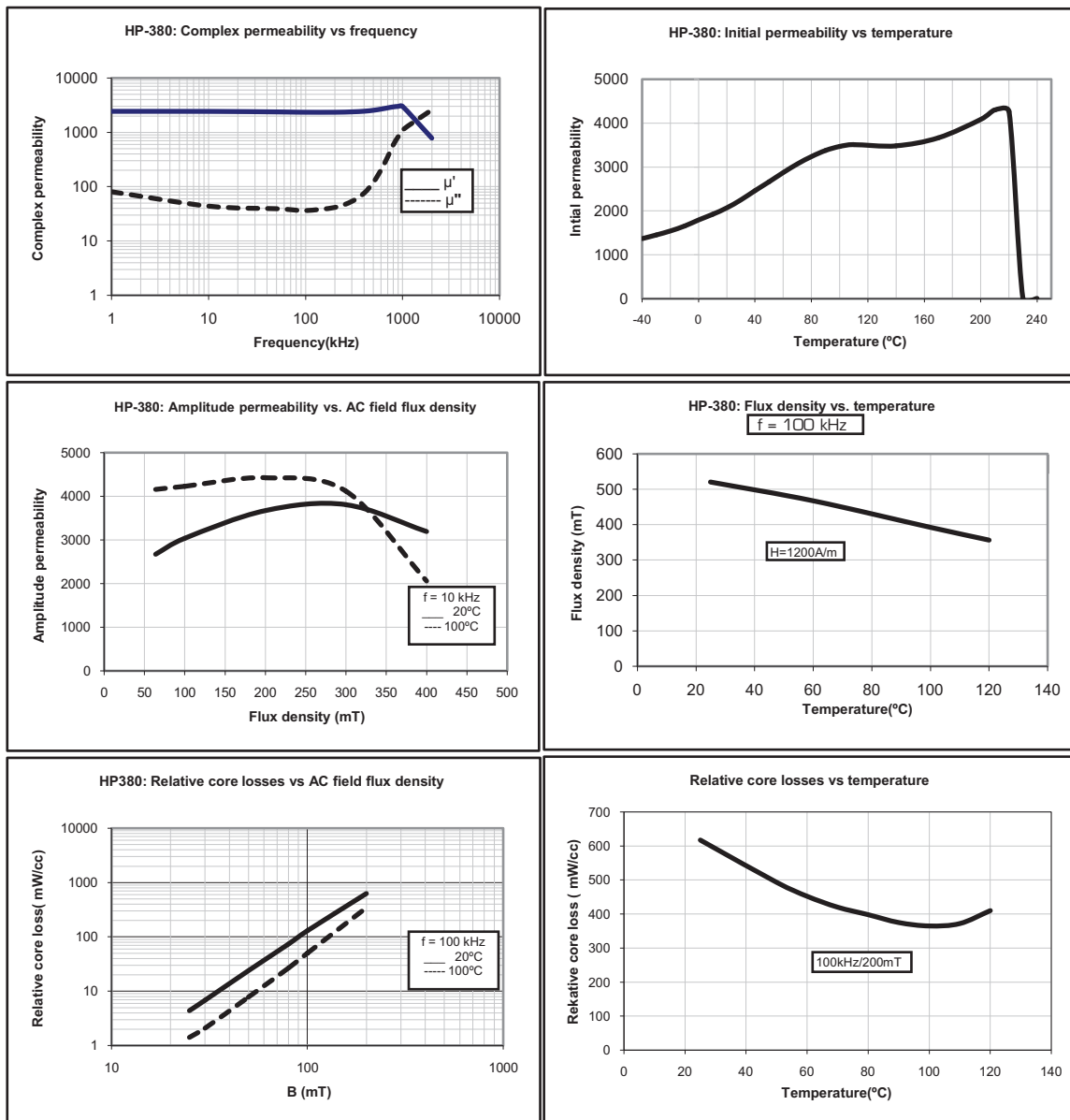

All measurements made on Toroid OD= 30mm, ID=20mm Ht=10mm.

HP-300 : Power Transformer Grade

Properties	Symbol	Unit	Test condition	Values
Initial permeability ($\pm 25\%$)	μ_i		0.1mT, 25°C	2200
Flux density (min)	Bs	mT	1200A/m, 25°C	510
			1200A/m, 100°C	420
Coercive Field (max)	Hc	A/m	10kHz, 25°C	11
Hysteris material Coefficient (max)	η_B	$10^{-6}/mT$	25°C	1
Curie Temperature (min)	Tc	°C		210
Density (min)	d	kg/m ³	25°C	4850
Temperature Coeff. of permeability (max)	α_F	$10^{-6}/K$	-40 to 80°C	4
Resisitivity (min)	ρ	Ωm	25°C	8
Powerloss (max)	Pc	mW/cc	100kHz, 200mT, 100°C	300

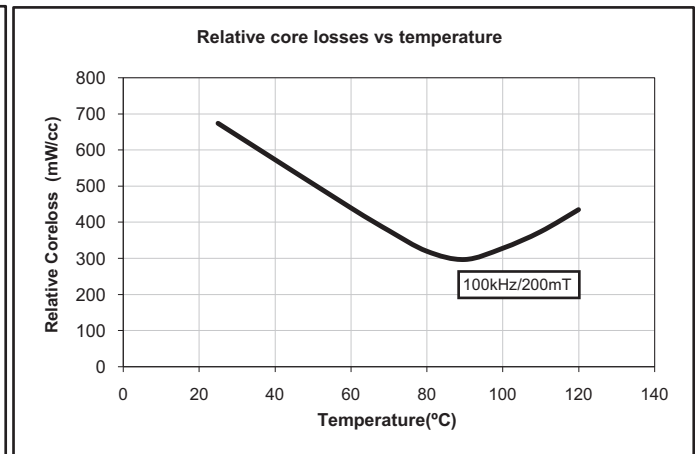
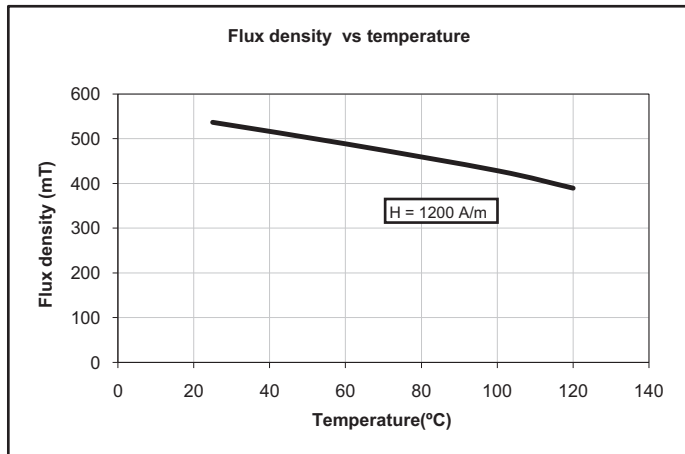
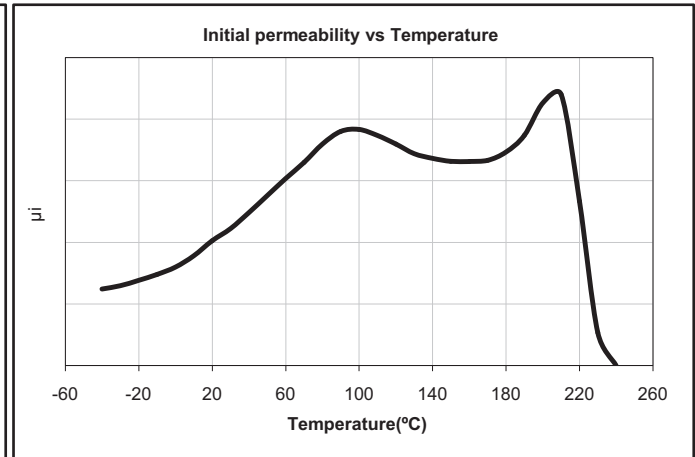
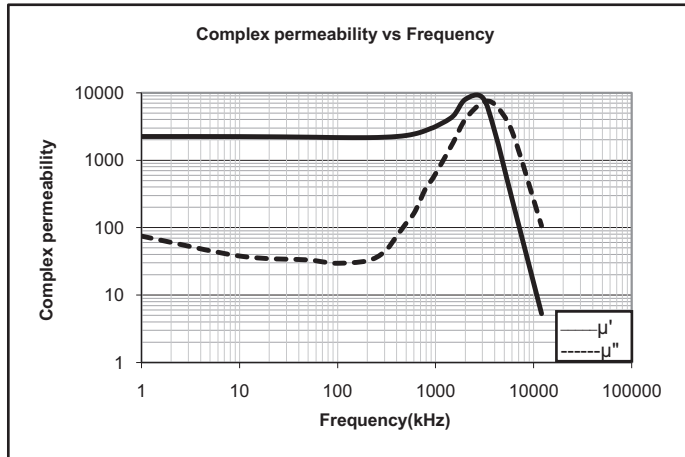

All measurements made on Toroid OD= 30mm, ID=20mm Ht=10mm.

HPT - 450 : Power Transformer Grade

Properties	Symbol	Unit	Test condition	Values
Initial permeability (±25%)	μ_i		0.1mT, 25°C	2400
Flux density (min)	Bs	mT	1200A/m, 25°C	510
			1200A/m, 100°C	410
Coercive Field (max)	Hc	A/m	10kHz, 25°C	8
Hysteris material Coefficient (max)	η_B	$10^{-6}/mT$	25°C	1.1
Curie Temperature (min)	Tc	°C		200
Density (min)	d	kg/m ³	25°C	4800
Temperature Coeff. of permeability (max)	α_F	$10^{-6}/K$	-40 to 80°C	2.5
Resisitivity (min)	ρ	Ωm	25°C	3
Powerloss (max)	Pc	mW/cc	100kHz, 200mT, 100°C	450

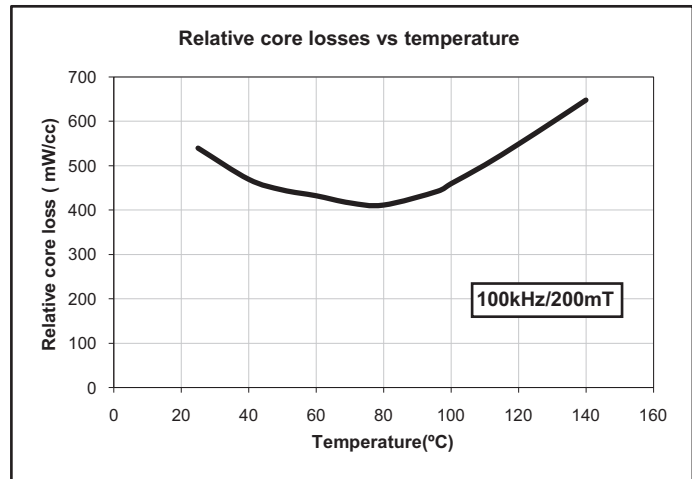
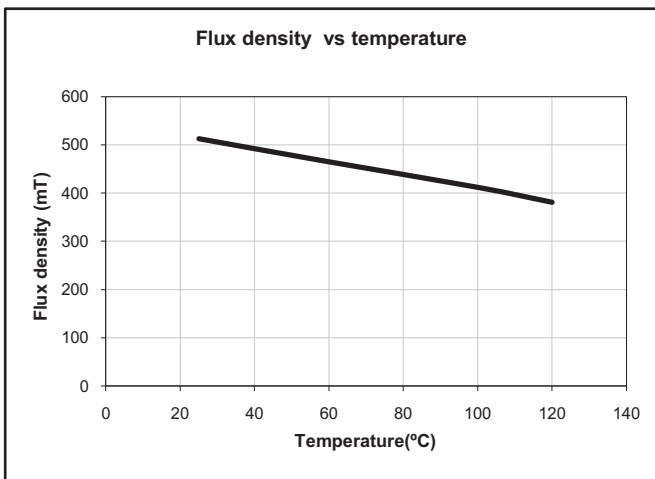
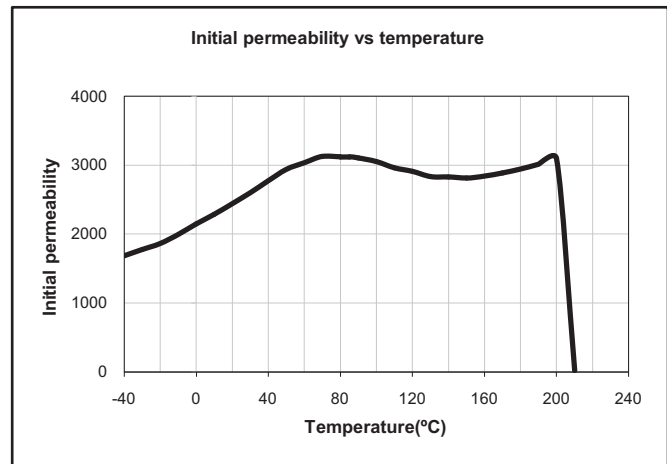
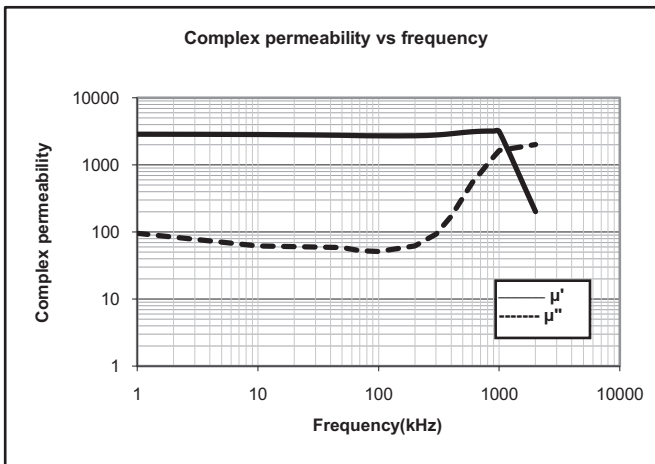

All measurements made on Toroid OD= 30mm, ID=20mm Ht=10mm.

MSB-5S : Wideband Transformer Grade

Properties	Symbol	Unit	Test condition	Values
Initial permeability ($\pm 25\%$)	μ_i		0.1mT, 25°C	3000
Flux density (min)	Bs	mT	1200A/m, 25°C	480
			1200A/m, 100°C	330
Relative loss factor $\tan\delta/\mu_i$ (max)	$\tan\delta/\mu_i$	10^{-6}	0.25mT, 100kHz & 25°C	6
Coercive Field (max)	Hc	A/m	10kHz, 25°C	15
Hysteris material Coefficient (max)	η_b	$10^{-6}/mT$	25°C	0.3
Curie Temperature (min)	Tc	°C		170
Density (min)	d	kg/m ³	25°C	4900
Temperature Coeff. of permeability (max)	α_f	$10^{-6}/K$	-40 to 80°C	1.2
Resisitivity (min)	ρ	Ωm	25°C	1

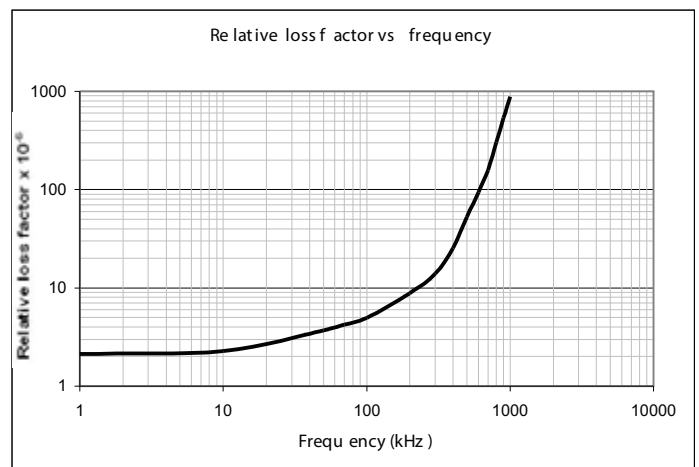
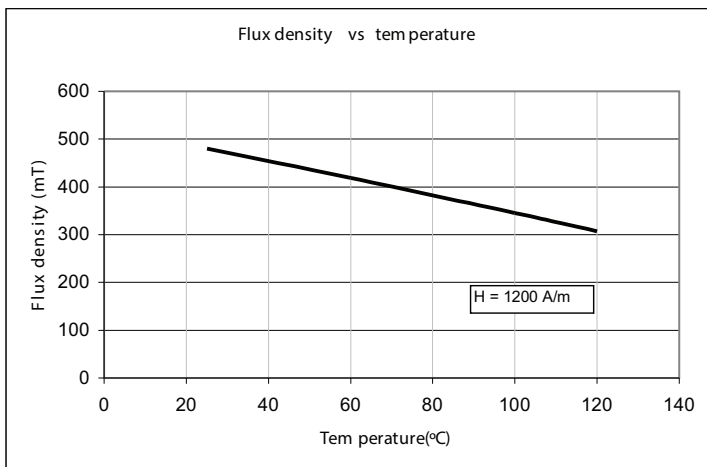
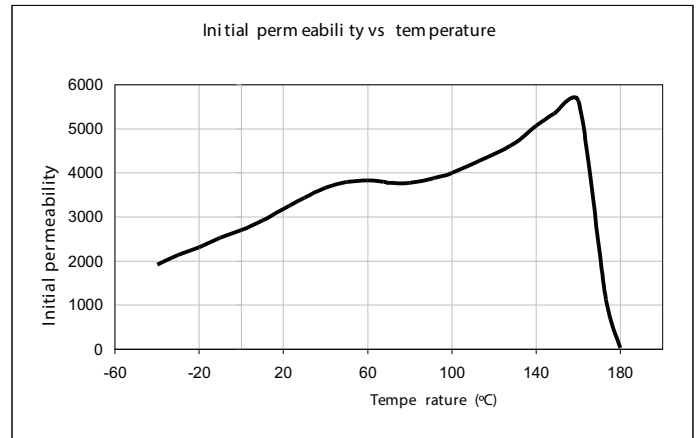
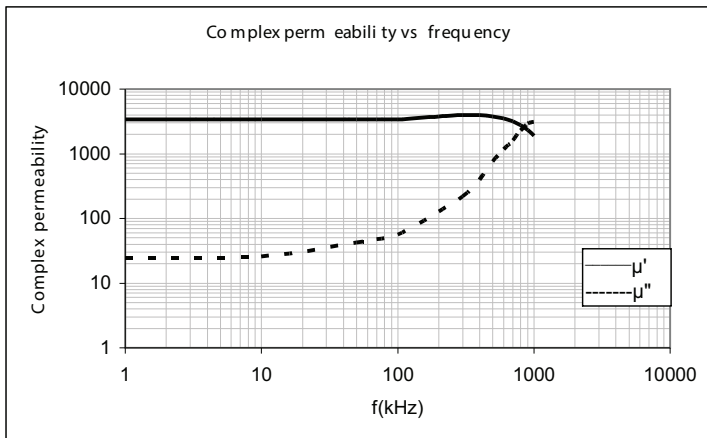

All measurements made on Toroid OD= 30mm, ID=20mm Ht=10mm.

HPT - 400 : Power Transformer Grade

Properties	Symbol	Unit	Test condition	Values
Initial permeability ($\pm 25\%$)	μ_i		0.1mT, 25°C	3000
Relative loss factor	$\tan\delta/\mu_i$	$\times 10^{-6}$	10kHz, 25°C	2
Flux density (min)	Bs	mT	1200A/m, 25°C	500
			1200A/m, 100°C	390
Coercive Field (max)	Hc	A/m	10kHz, 25°C	10
Curie Temperature (min)	Tc	°C		220
Density (min)	d	kg/m ³	25°C	4800
Temperature Coeff. of permeability (max)	α_F	$10^{-6}/K$	-40 to 80°C	1.5
Resistivity (min)	ρ	Ωm	25°C	7
Powerloss (max)	Pc	mW/cc	100kHz, 200mT, 25°C	400
			100kHz, 200mT, 100°C	400

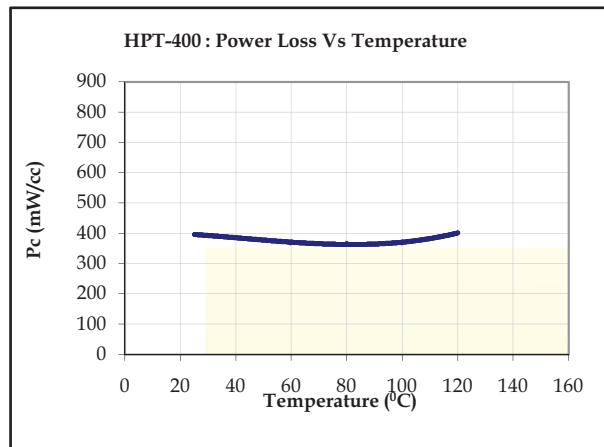
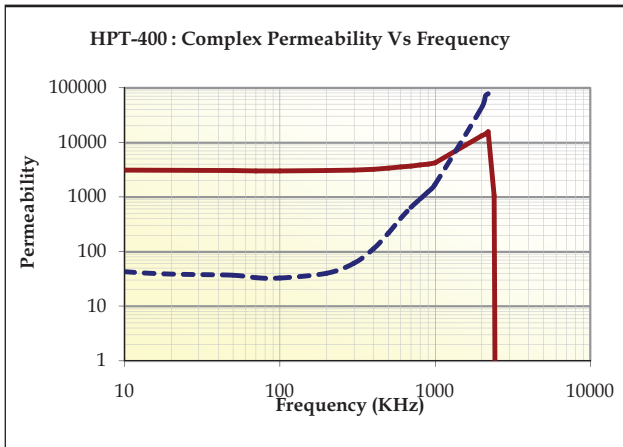
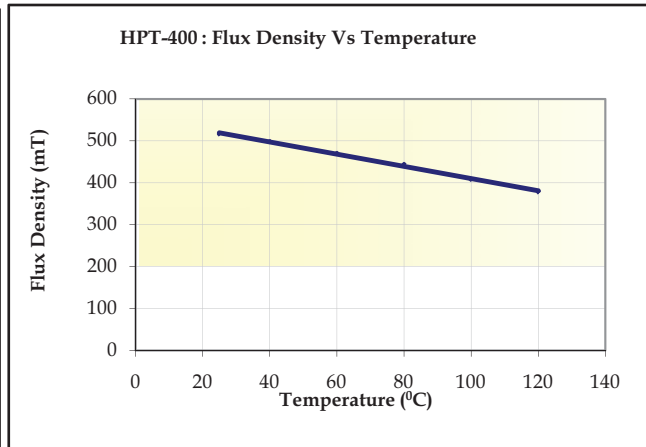
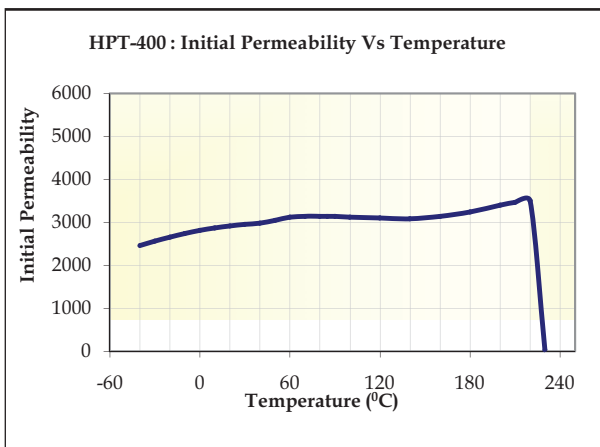

All measurements made on Toroid OD=30mm, ID=20mm Ht=10mm.

HB - 040 : Wideband Transformer Grade

Properties	Symbol	Unit	Test condition	Values
Initial permeability ($\pm 25\%$)	μ_i		0.1mT, 25°C	3800
Flux density (min)	Bs	mT	1200A/m, 25°C	550
			1200A/m, 100°C	435
Relative loss factor $\tan\delta/\mu_i$ (max)	$\tan\delta/\mu_i$	10^{-6}	0.25mT, 100kHz & 25°C	4
Coercive Field (max)	Hc	A/m	10kHz, 25°C	15
Hysteris material Coefficient (max)	η_B	$10^{-6}/\text{mT}$	25°C	0.3
Curie Temperature (min)	Tc	°C		205
Density (min)	d	kg/m ³	25°C	4900
Temperature Coeff. of permeability (max)	α_F	$10^{-6}/\text{K}$	-40 to 80°C	1.2
Resisitivity (min)	ρ	Ωm	25°C	2

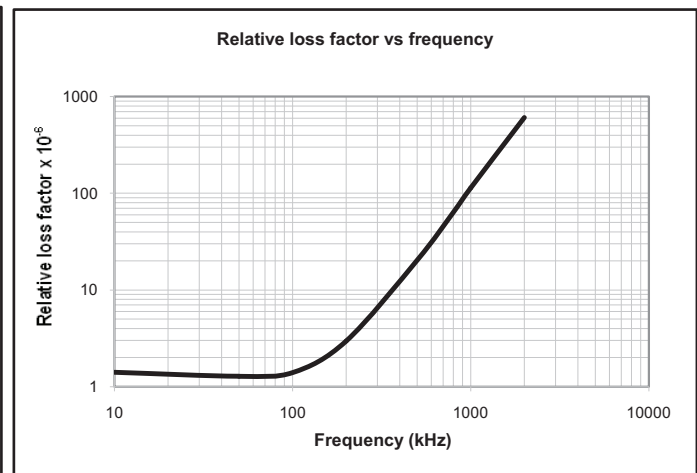
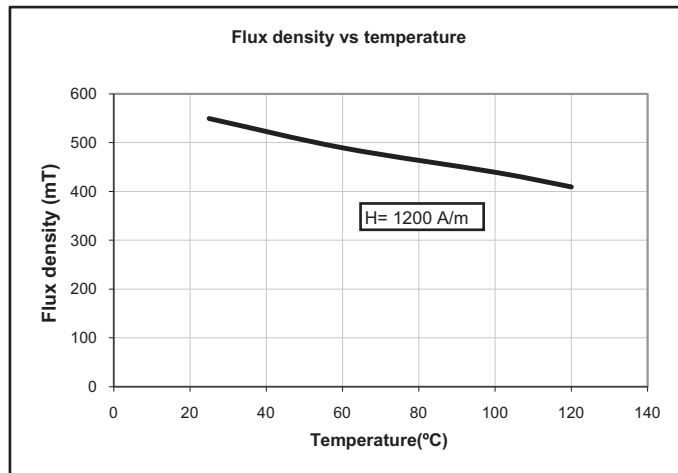
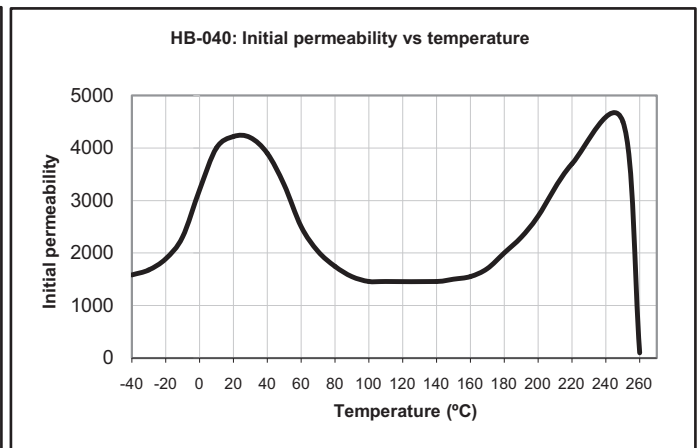
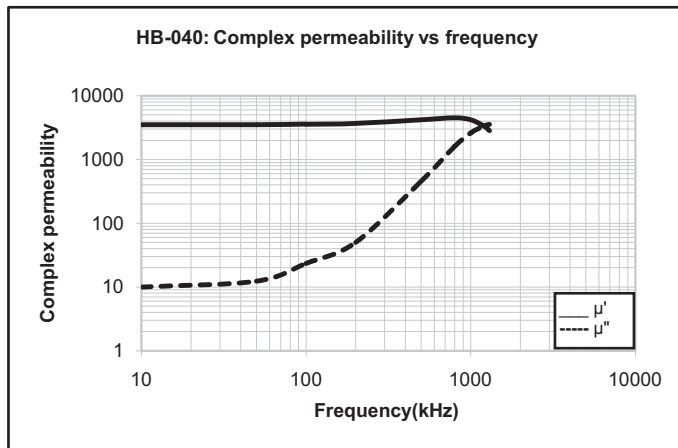

All measurements made on Toroid OD= 30mm, ID=20mm Ht=10mm.

HM 030 : Wideband Transformer Grade

Properties	Symbol	Unit	Test condition	Values
Initial permeability ($\pm 25\%$)	μ_i		0.1mT, 25°C	3000
Flux density (min)	Bs	mT	1200A/m, 25°C	480
			1200A/m, 100°C	330
Relative loss factor $\tan\delta/\mu_i$ (max)	$\tan\delta/\mu_i$	10^{-6}	0.25mT, 100kHz & 25°C	6
Coercive Field (max)	Hc	A/m	10kHz, 25°C	15
Hysteris material Coefficient (max)	η_B	$10^{-6}/mT$	25°C	0.3
Curie Temperature (min)	Tc	°C		180
Density (min)	d	kg/m ³	25°C	4900
Temperature Coeff. of permeability (max)	α_F	$10^{-6}/K$	-40 to 80°C	1.2
Resisitivity (min)	ρ	Ωm	25°C	1

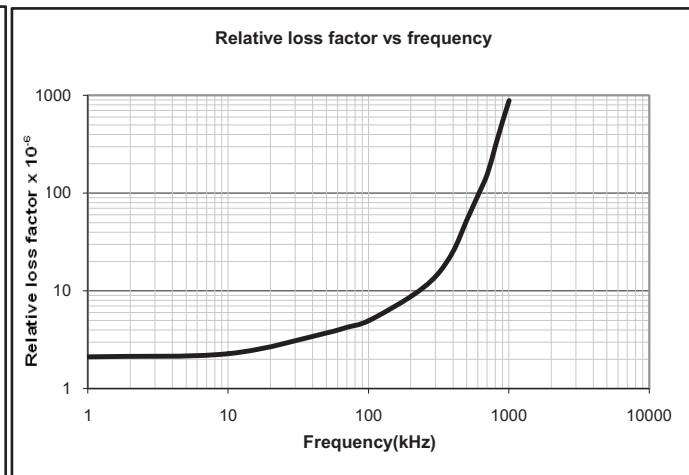
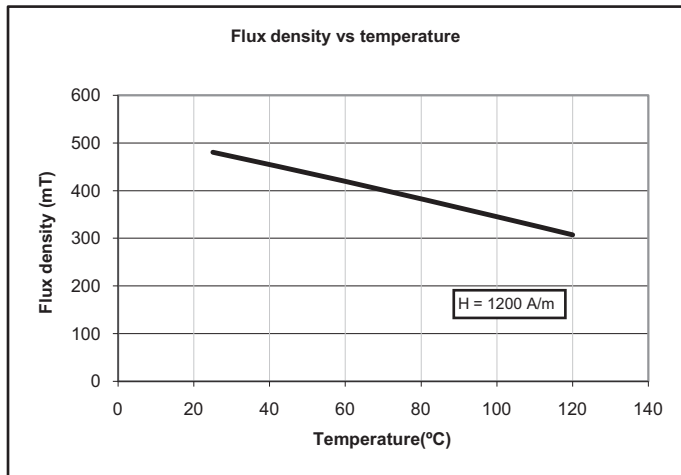
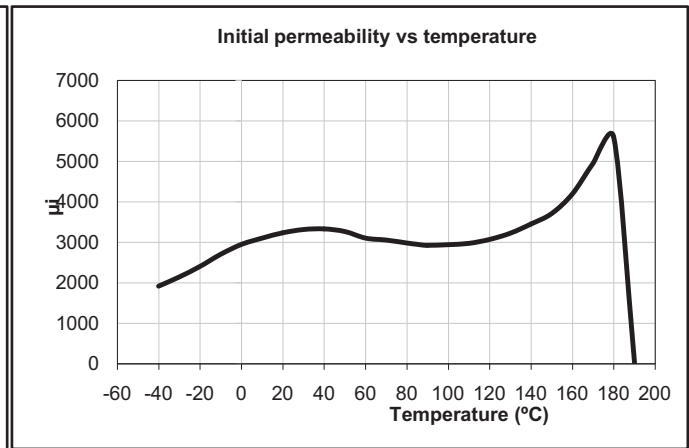
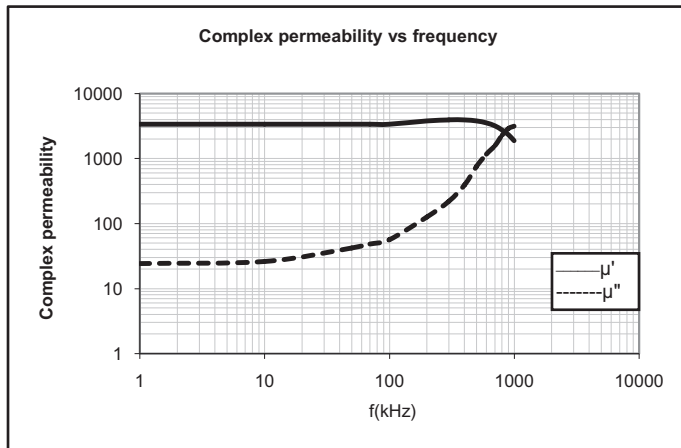

All measurements made on Toroid OD= 30mm, ID=20mm Ht=10mm.

HM - 040 : Wideband Transformer Grade

Properties	Symbol	Unit	Test condition	Values
Initial permeability ($\pm 25\%$)	μ_i		0.1mT, 25°C	4000
Flux density (min)	Bs	mT	1200A/m, 25°C	470
			1200A/m, 100°C	330
Relative loss factor $\tan\delta/\mu_i$ (max)	$\tan\delta/\mu_i$	10^{-6}	0.25mT, 10kHz & 25°C	3
			0.25mT, 100kHz & 25°C	10
Coercive Field (max)	Hc	A/m	10kHz, 25°C	3
Hysteris material Coefficient (max)	η_B	$10^{-6}/mT$	25°C	0.8
Curie Temperature (min)	Tc	°C		170
Density (min)	d	kg/m ³	25°C	4900
Temperature Coeff. of permeability (max)	α_F	$10^{-6}/K$	-40 to 80°C	3
Resisitivity (min)	ρ	Ωm	25°C	1

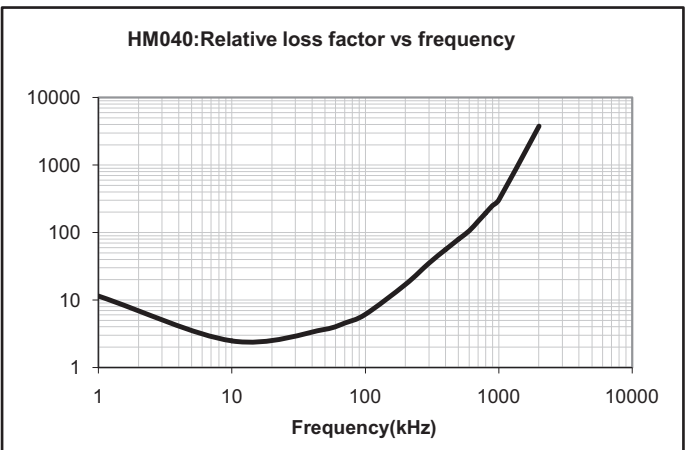
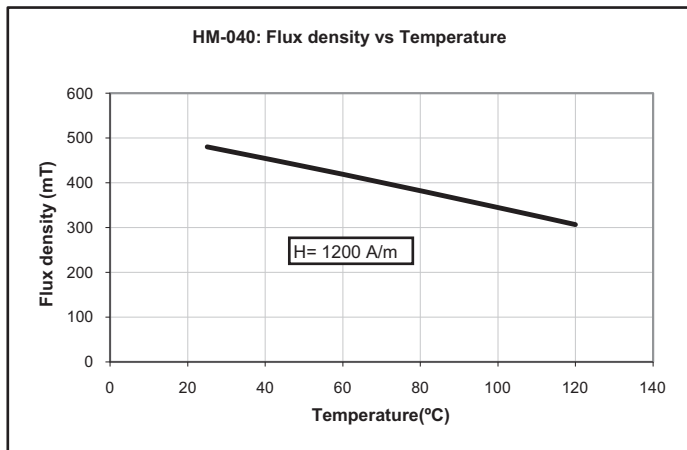
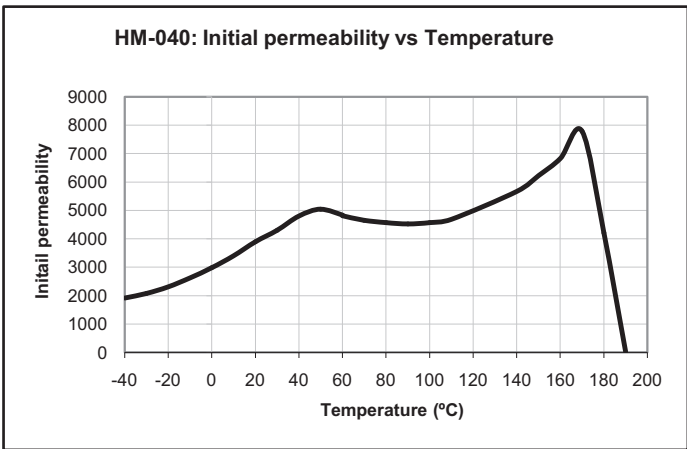
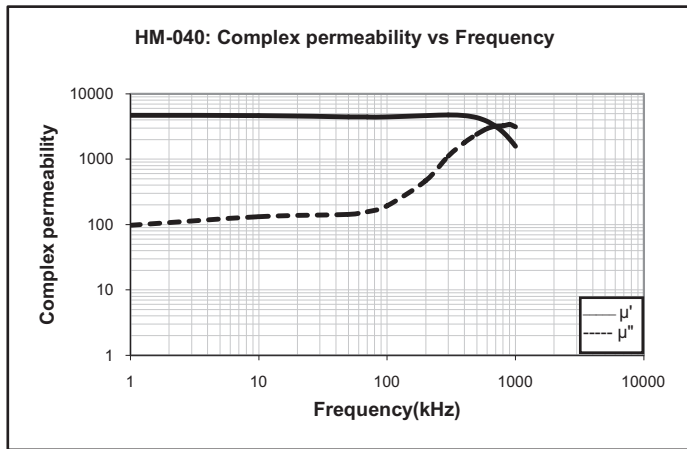

All measurements made on Toroid OD= 30mm, ID=20mm Ht=10mm.

HM - 045 : CFL Transformer

Properties	Symbol	Unit	Test condition	Values
Initial permeability ($\pm 25\%$)	μ_i		0.1mT, 25°C	4500
Flux density (min)	Bs	mT	1200A/m, 25°C	470
			1200A/m, 100°C	330
Relative loss factor $\tan\delta/\mu_i$ (max)	$\tan\delta/\mu_i$	10^{-6}	0.25mT, 10kHz & 25°C	3
			0.25mT, 100kHz & 25°C	10
Coercive Field (max)	Hc	A/m	10kHz, 25°C	3
Curie Temperature (min)	Tc	°C		170
Density (min)	d	kg/m ³	25°C	4900
Temperature Coeff. of permeability (max)	α_F	$10^{-6}/K$	-40 to 80°C	2.5

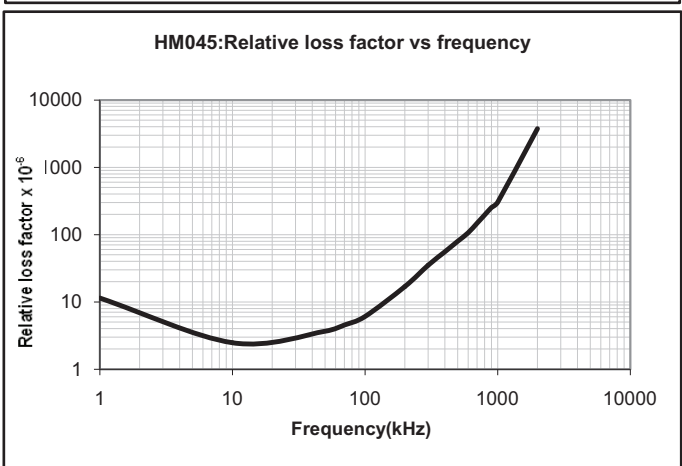
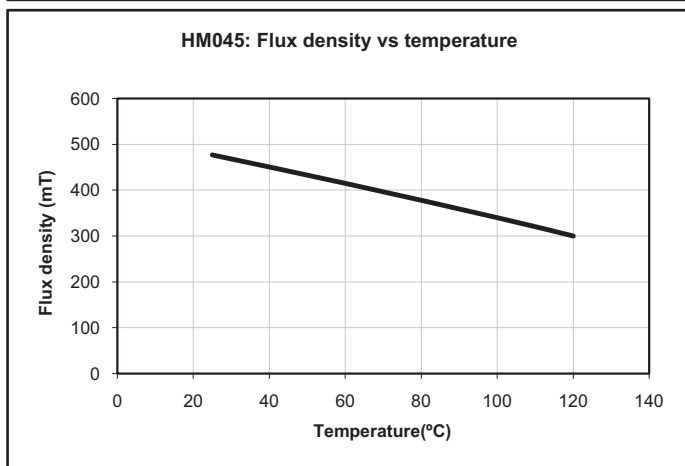
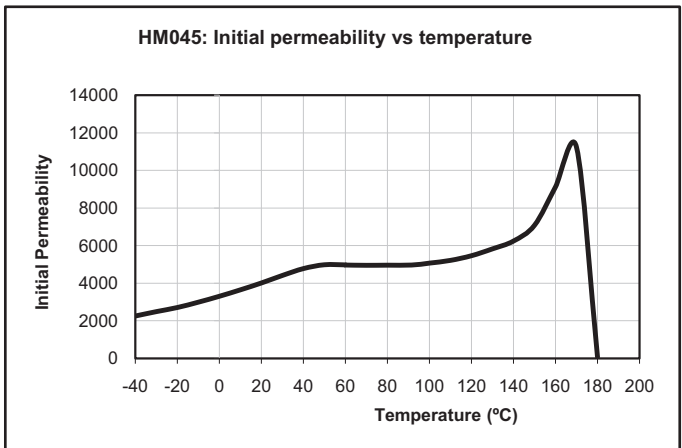
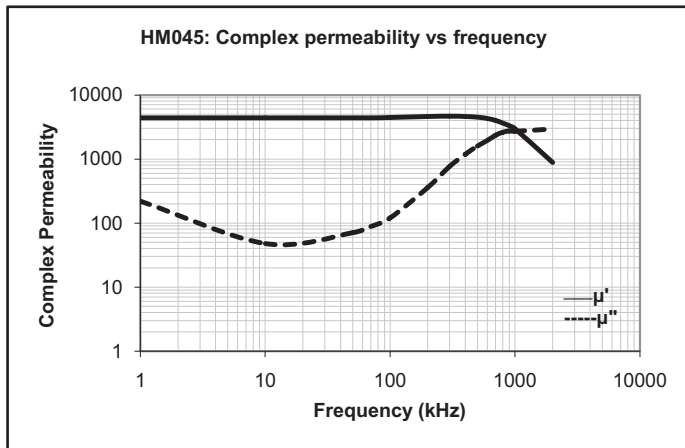

All measurements made on Toroid OD= 22mm, ID=14mm Ht=6mm.

GQ - 5C : Wideband Transformer Grade

Properties	Symbol	Unit	Test condition	Values
Initial permeability (±25%)	μ_i		0.1mT, 25°C	5000
Flux density (min)	Bs	mT	1200A/m, 25°C	450
			1200A/m, 100°C	300
Relative loss factor $\tan\delta/\mu_i$ (max)	$\tan\delta/\mu_i$	10^{-6}	0.25mT, 10kHz & 25°C	3
			0.25mT, 100kHz & 25°C	15
Coercive Field (max)	Hc	A/m	10kHz, 25°C	3
Hysteris material Coefficient (max)	η_B	$10^{-6}/mT$	25°C	0.8
Curie Temperature (min)	Tc	°C		140
Density (min)	d	kg/m ³	25°C	4900
Temperature Coeff. of permeability (max)	α_F	$10^{-6}/K$	-40 to 80°C	3
Resisitivity (min)	ρ	Ωm	25°C	1

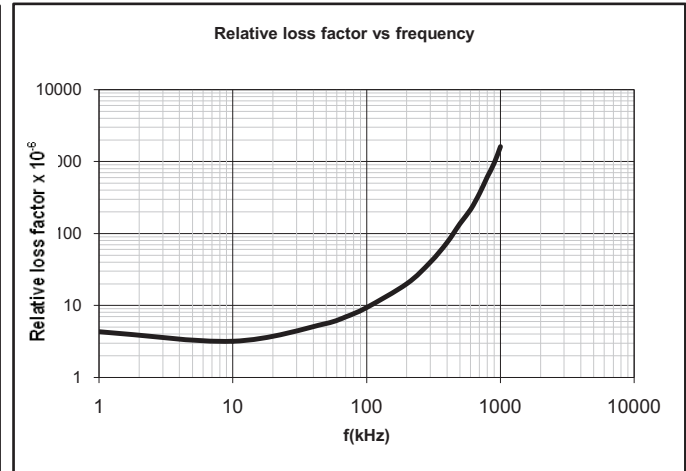
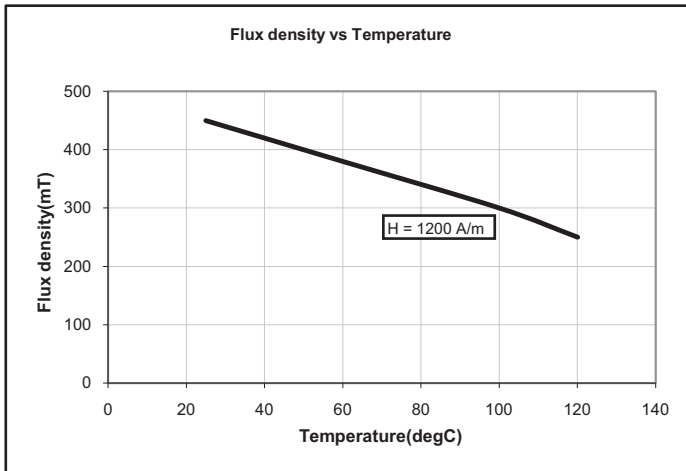
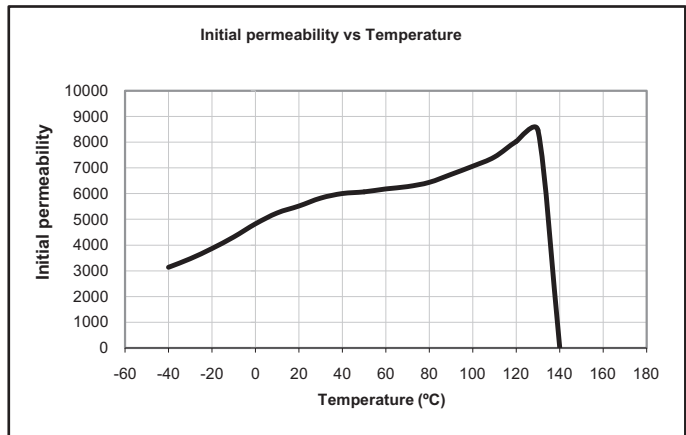
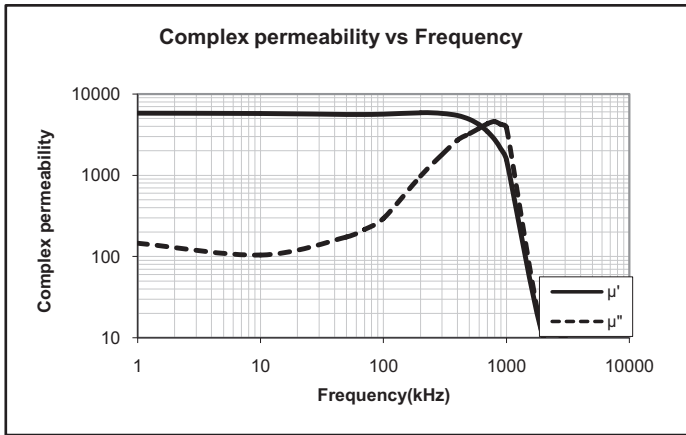

All measurements made on Toroid OD= 30mm, ID=20mm Ht=10mm.

HM - 060 : Wideband Transformer Grade

Properties	Symbol	Unit	Test condition	Values
Initial permeability (±25%)	μ_i		0.1mT, 25°C	6000
Flux density (min)	Bs	mT	1200A/m, 25°C	400
			1200A/m, 100°C	240
Relative loss factor $\tan\delta/\mu_i$ (max)	$\tan\delta/\mu_i$	10^{-6}	0.25mT, 10kHz & 25°C	5
			0.25mT, 100kHz & 25°C	40
Coercive Field (max)	Hc	A/m	10kHz, 25°C	5
Hysteris material Coefficient (max)	η_B	$10^{-6}/mT$	25°C	0.6
Curie Temperature (min)	Tc	°C		130
Density (min)	d	kg/m ³	25°C	4900
Temperature Coeff. of permeability (max)	α_F	$10^{-6}/K$	-40 to 80°C	2
Resisitivity (min)	ρ	Ωm	25°C	0.6

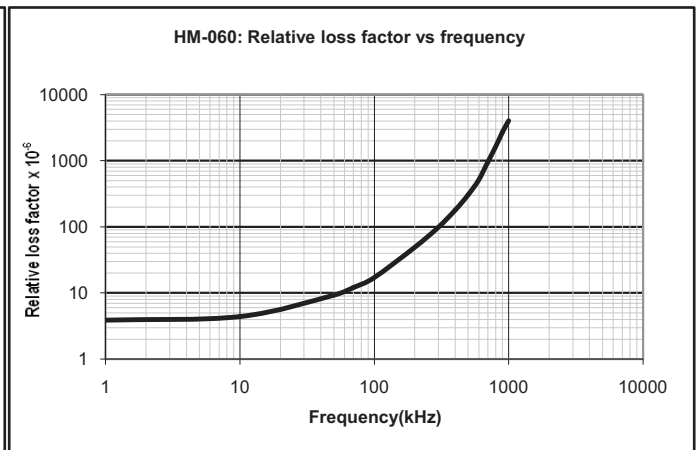
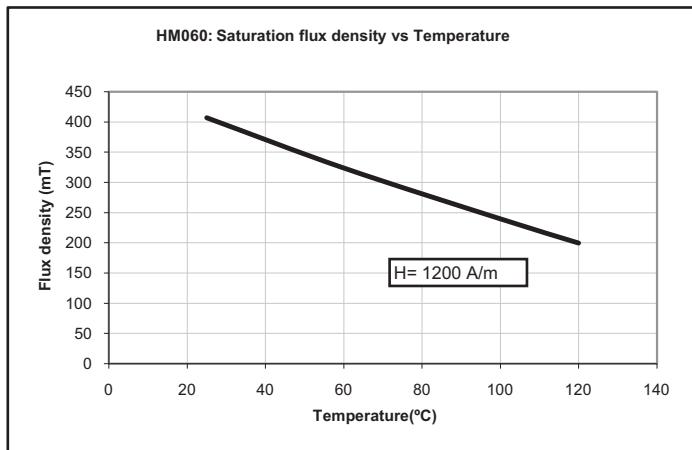
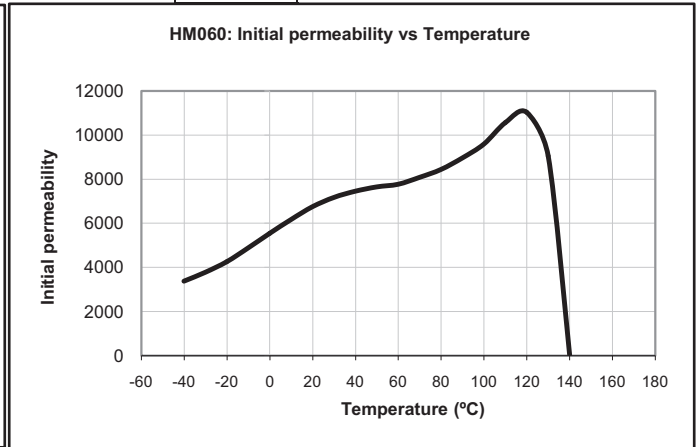
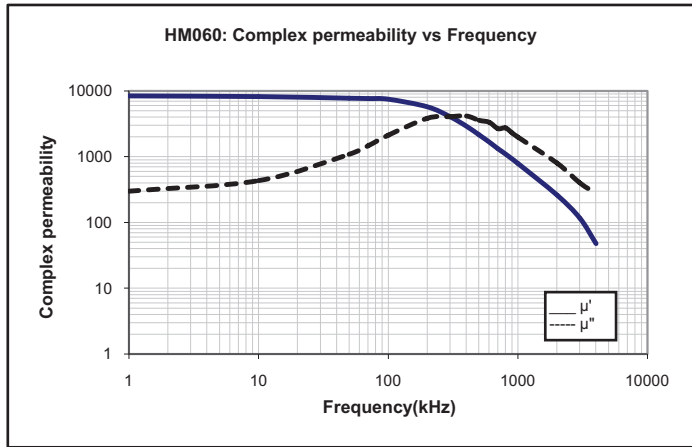

All measurements made on Toroid OD= 30mm, ID=20mm Ht=10mm.

HM - 070 : Wideband Transformer Grade

Properties	Symbol	Unit	Test condition	Values
Initial permeability ($\pm 25\%$)	μ_i		0.1mT, 25°C	7000
Flux density (min)	Bs	mT	1200A/m, 25°C	400
			1200A/m, 100°C	240
Relative loss factor $\tan\delta/\mu_i$ (max)	$\tan\delta/\mu_i$	10^{-6}	0.25mT, 10kHz & 25°C	5
			0.25mT, 100kHz & 25°C	60
Coercive Field (max)	Hc	A/m	10kHz, 25°C	4
Hysteris material Coefficient (max)	η_B	$10^{-6}/mT$	25°C	0.5
Curie Temperature (min)	Tc	°C		120
Density (min)	d	kg/m ³	25°C	4900
Temperature Coeff. of permeability (max)	α_F	$10^{-6}/K$	-40 to 80°C	2
Resisitivity (min)	ρ	Ωm	25°C	0.5

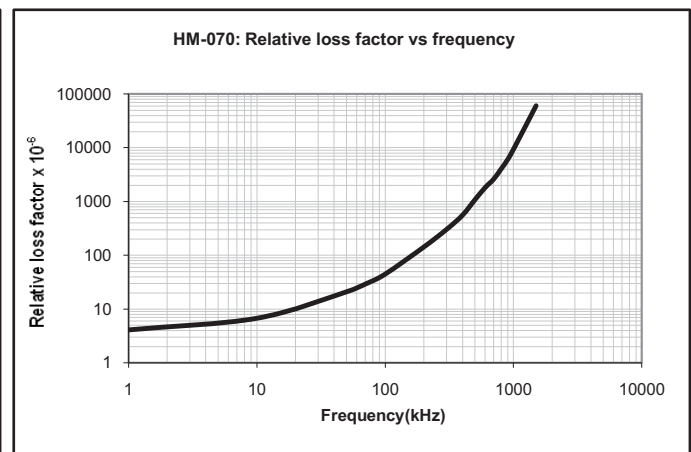
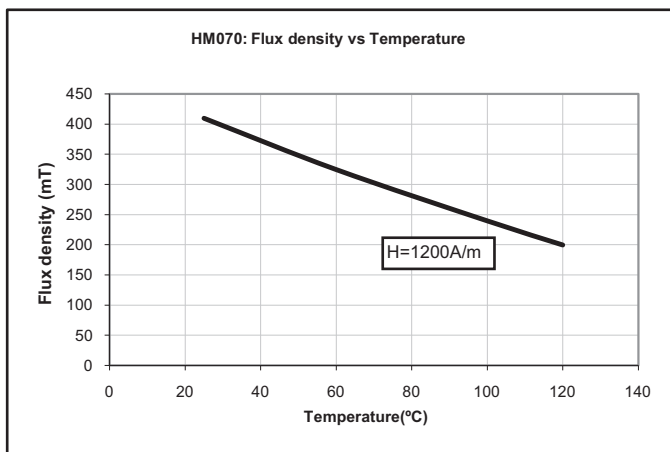
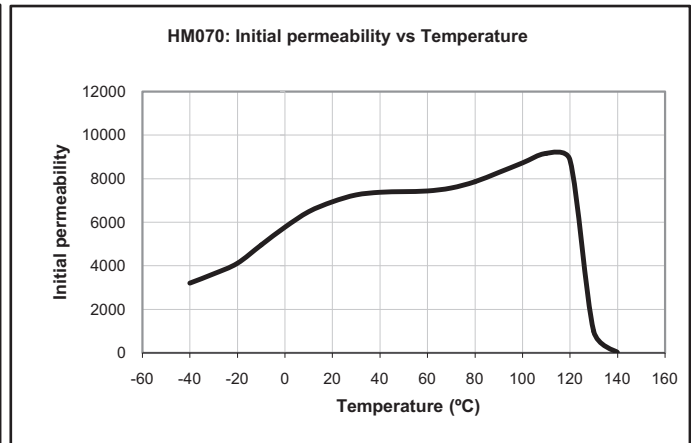
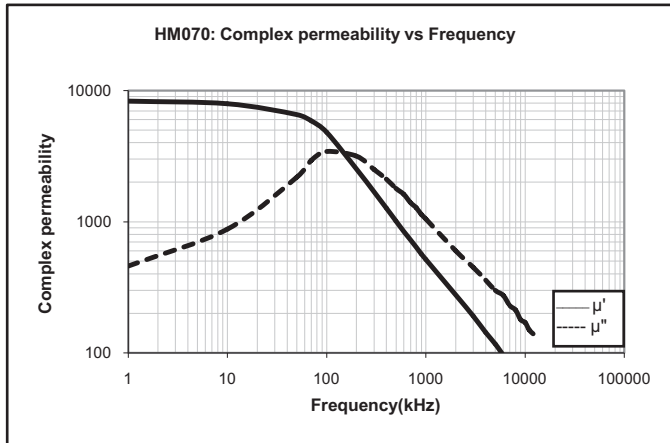

All measurements made on Toroid OD= 30mm, ID=20mm Ht=10mm.

HM - 100 : For Wideband Transformer Application

Properties	Symbol	Unit	Test condition	Values
Initial permeability ($\pm 25\%$)	μ_i		0.1mT, 25°C	10000
Flux density (min)	Bs	mT	1200A/m, 25°C	430
			1200A/m, 100°C	240
Relative loss factor $\tan\delta/\mu_i$ (max)	$\tan\delta/\mu_i$	10^{-6}	0.25mT, 10kHz & 25°C	3
			0.25mT, 100kHz & 25°C	20
Curie Temperature (min)	Tc	°C		120
Density (min)	d	kg/m ³	25°C	4900
Temperature Coeff. of permeability (max)	α_F	$10^{-6}/K$	-40 to 80°C	2
Resisitivity (min)	ρ	Ωm	25°C	0.5

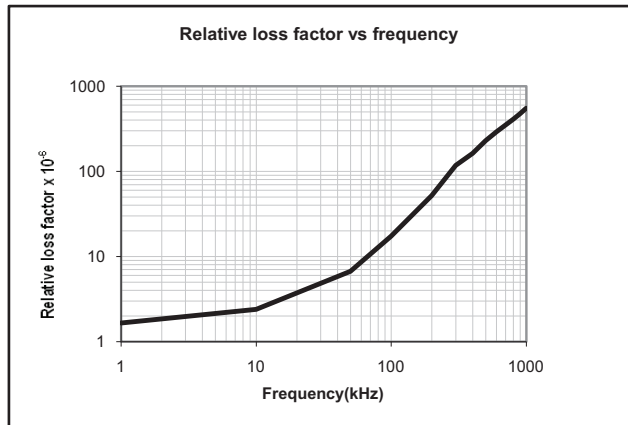
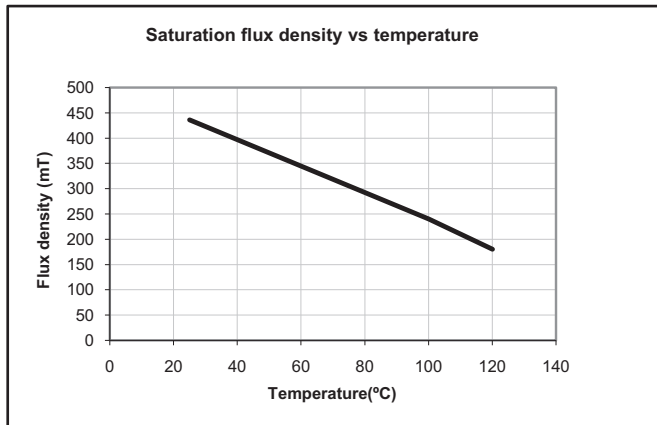
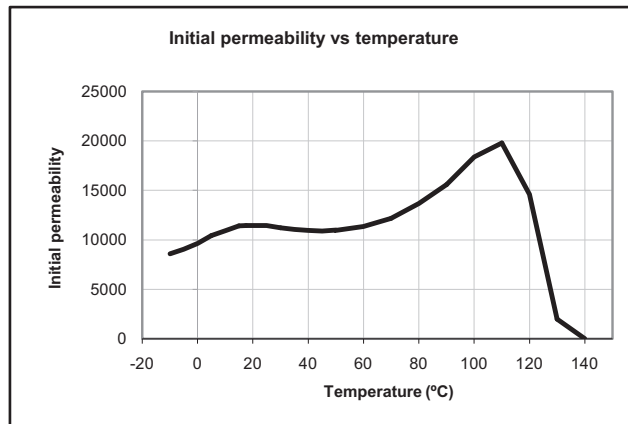
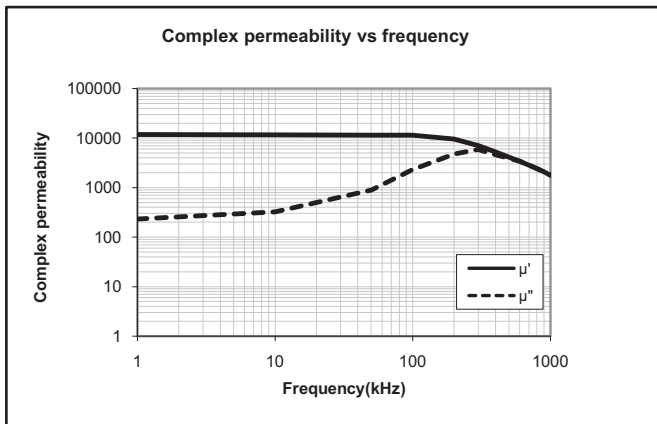

All measurements made on Toroid OD= 10mm, ID=06mm Ht=04mm

Technical drawing of a toroid core with the following dimensions:
 Outer Diameter (OD): 10mm
 Inner Diameter (ID): 06mm
 Height (Ht): 04mm

Typical Dimension
 OD = 10 \pm 0.6mm
 ID = 06 \pm 0.4mm
 Ht = 04 \pm 0.2mm

Typical Inductance factor (AL) = 4100 \pm 10% nH

HT - 08 :

Properties	Symbol	Unit	Test condition	Values
Initial permeability ($\pm 25\%$)	μ_i		0.1mT, 25°C	800
Flux density (min)	Bs	mT	1200A/m, 25°C	430
			1200A/m, 100°C	320
Relative loss factor $\tan\delta/\mu_i$ (max)	$\tan\delta/\mu_i$	10^{-6}	0.25mT, 10kHz & 25°C	10
			0.25mT, 100kHz & 25°C	10
Coercive Field (max)	Hc	A/m	10kHz, 25°C	20
Curie Temperature (min)	Tc	°C		190
Density (min)	d	kg/m ³	25°C	4850
Temperature Coeff. of permeability (max)	α_F	$10^{-6}/K$	-40 to 80°C	± 3
Resistivity (min)	ρ	Ωm	25°C	10

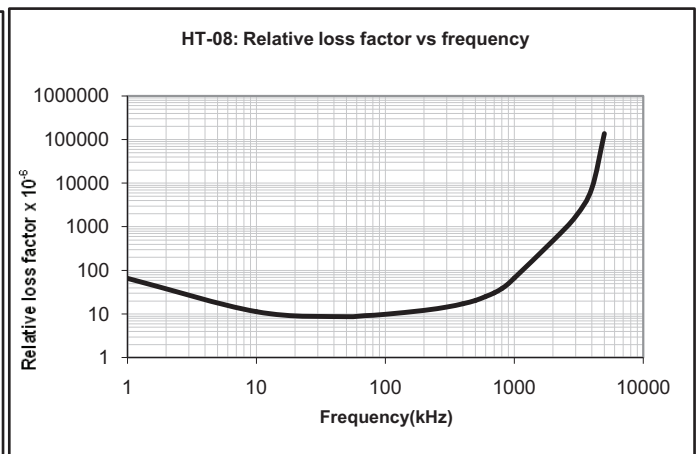
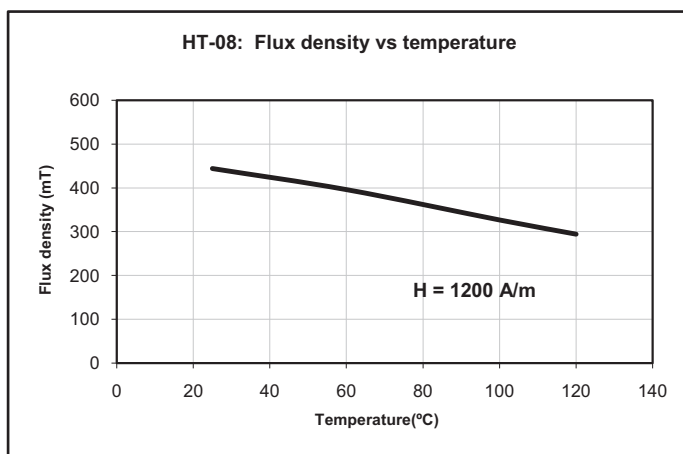
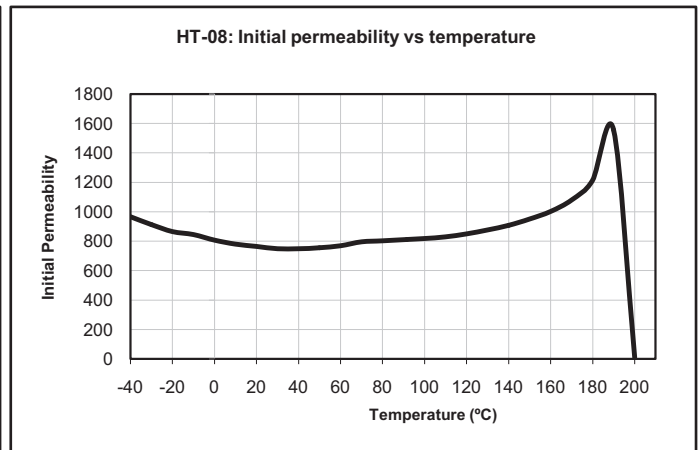
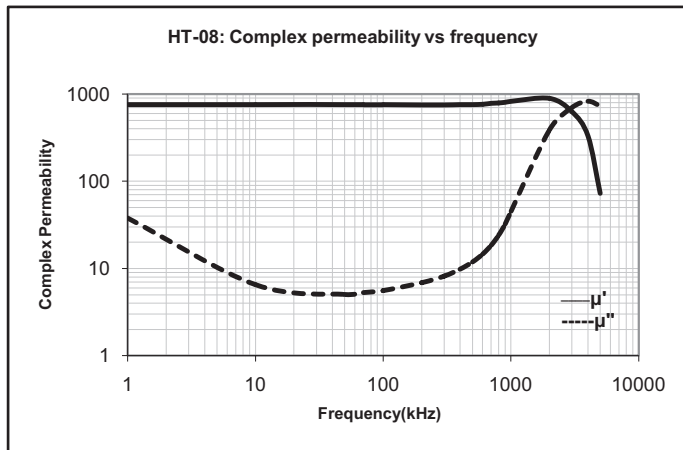

All measurements made on Toroid OD= 30mm, ID=20mm Ht=10mm.

HT - 020 : RFID antenna grade

Properties	Symbol	Unit	Test condition	Values
Initial permeability ($\pm 25\%$)	μ_i		0.1mT, 25°C	2000
Flux density (min)	Bs	mT	1200A/m, 25°C	470
			1200A/m, 100°C	330
Relative loss factor $\tan\delta/\mu_i$ (max)	$\tan\delta/\mu_i$	10^{-6}	0.25mT, 10kHz & 25°C	6
			0.25mT, 100kHz & 25°C	10
Coercive Field (max)	Hc	A/m	10kHz, 25°C	14
Hysteris material Coefficient (max)	η_B	$10^{-6}/mT$	25°C	2
Curie Temperature (min)	Tc	°C		170
Density (min)	d	kg/m ³	25°C	4850
Temperature Coeff. of permeability (max)	α_F	$10^{-6}/K$	-40 to 80°C	± 0.4
Resisitivity (min)	ρ	Ωm	25°C	1

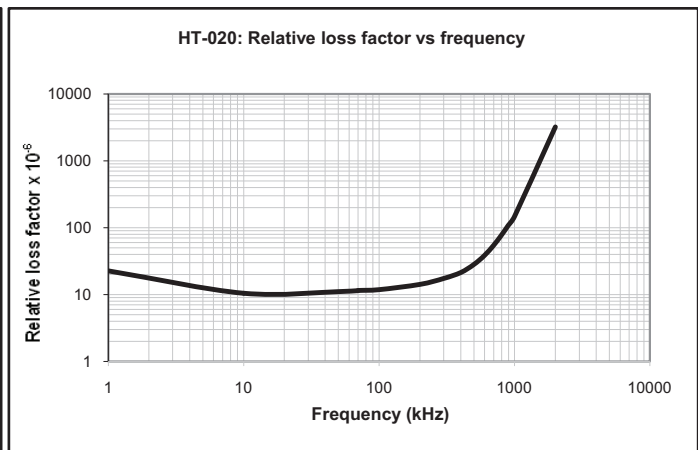
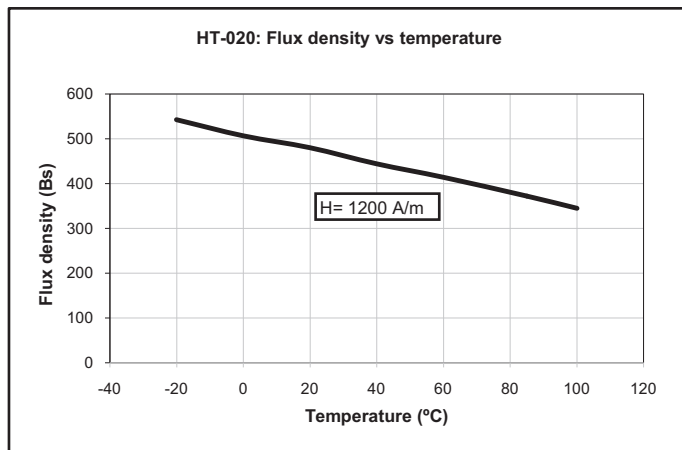
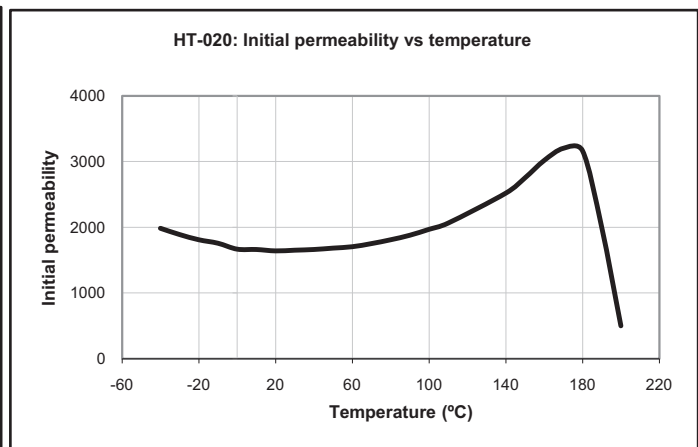
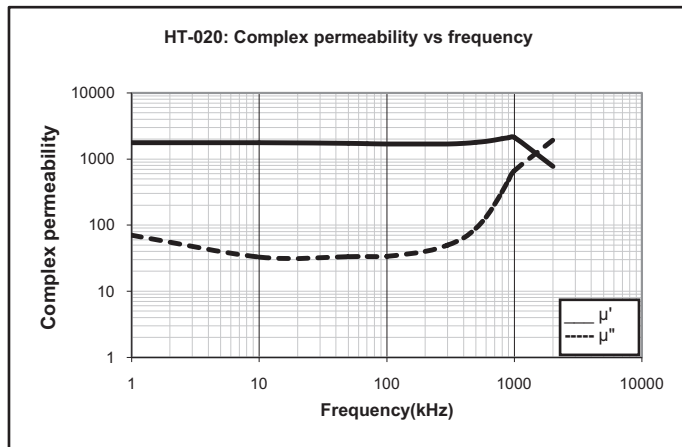

All measurements made on Toroid OD= 30mm, ID=20mm Ht=10mm.

HT - 35 : RFID antenna grade

Properties	Symbol	Unit	Test condition	Values
Initial permeability ($\pm 25\%$)	μ_i		0.1mT, 25°C	3400
Flux density (min)	Bs	mT	1200A/m, 25°C	510
			1200A/m, 100°C	390
Relative loss factor $\tan\delta/\mu_i$ (max)	$\tan\delta/\mu_i$	10^{-6}	0.25mT, 10kHz & 25°C	3
Permanent flux density	Br	mT	25°C	90
Coercive force	Hc	A/m	25°C	10
Curie Temperature (min)	Tc	°C		150
Density (min)	d	kg/m ³	25°C	4800
Temperature Coeff. of permeability (max)	α_F	$10^{-6}/K$	-40 to 80°C	2
Resisitivity (min)	ρ	Ωm	25°C	1

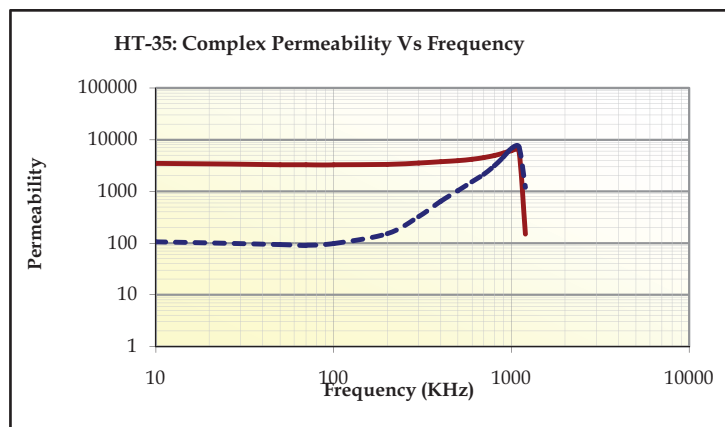
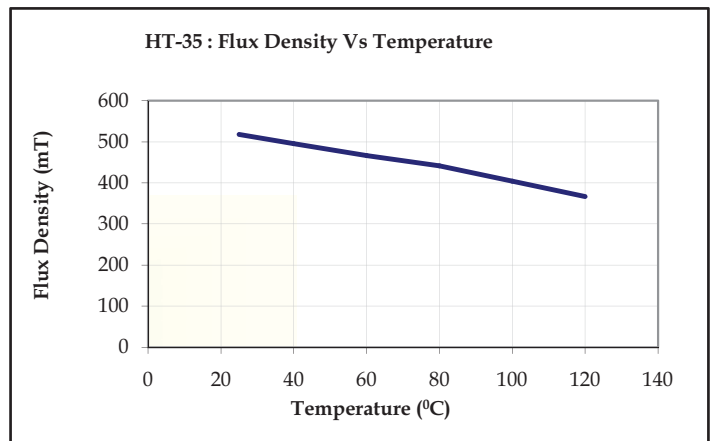
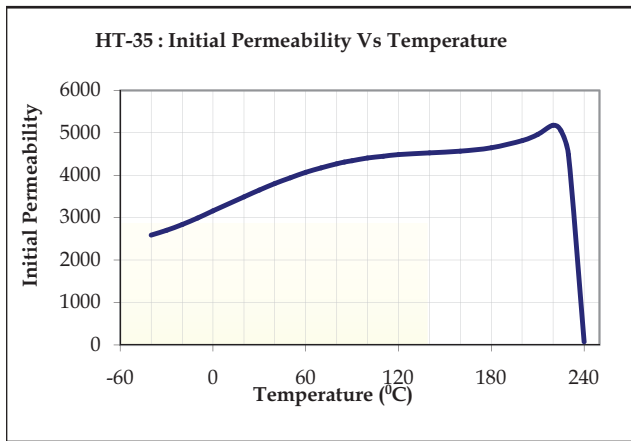

All measurements made on Toroid OD= 30mm, ID=20mm Ht=10mm.

HR - 4 : Ferrite Impeder Grade

Properties	Symbol	Unit	Test condition	Values
Initial permeability ($\pm 25\%$)	μ_i		0.1mT, 25°C	1200
Flux density (min)	Bs	mT	1200A/m, 25°C	440
			1200A/m, 100°C	350
Coercive Field (max)	Hc	A/m	10kHz, 25°C	10
Curie Temperature (min)	Tc	°C		240
Density (min)	d	kg/m ³	25°C	4800
Resisitivity (min)	ρ	Ωm	25°C	4
Powerloss (max)	Pc	mW/cc	400kHz/200mT/25°C	10000
			400kHz/200mT/100°C	7000

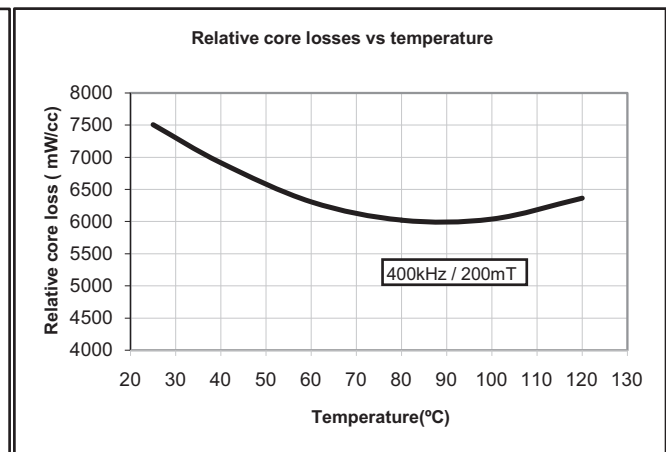
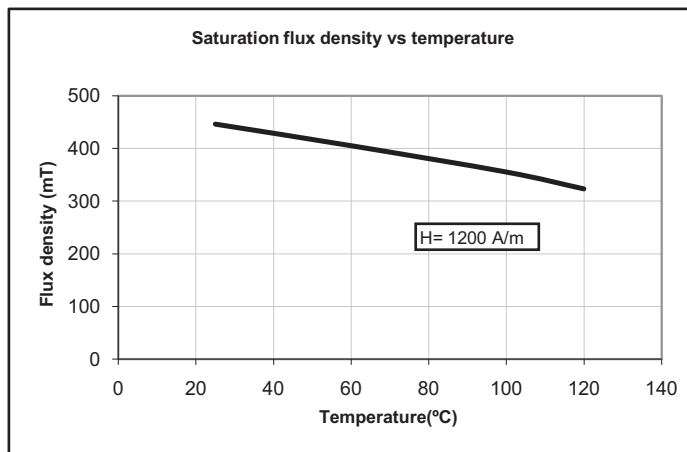
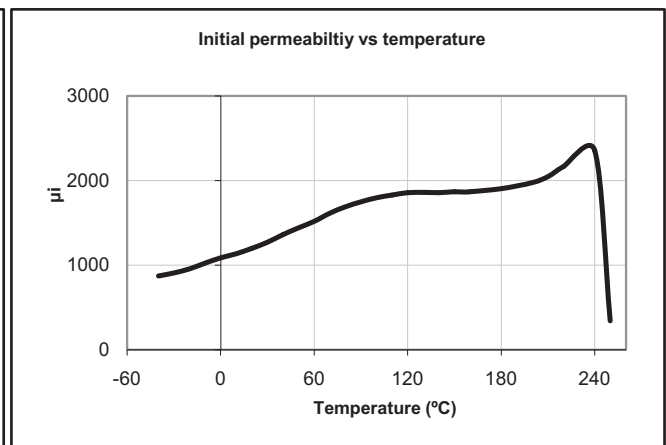
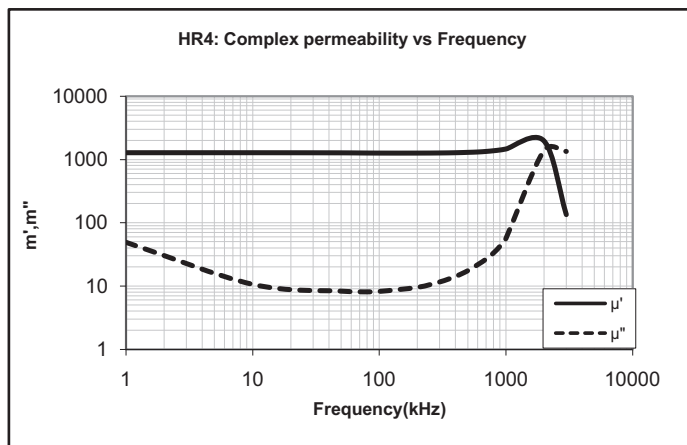

All measurements made on Toroid OD= 30mm, ID=20mm Ht=10mm.

HR - 4B : Ferrite Impeder Grade

Properties	Symbol	Unit	Test condition	Values
Initial permeability ($\pm 25\%$)	μ_i		0.1mT, 25°C	2000
Flux density (min)	Bs	mT	1200A/m, 25°C	500
			1200A/m, 100°C	400
Coercive Field (max)	Hc	A/m	10kHz, 25°C	10
Curie Temperature (min)	Tc	°C		210
Density (min)	d	kg/m ³	25°C	4800
Resisitivity (min)	ρ	Ωm	25°C	4
Powerloss (max)	Pc	mW/cc	400kHz/200mT/25°C	8000
			400kHz/200mT/100°C	6000

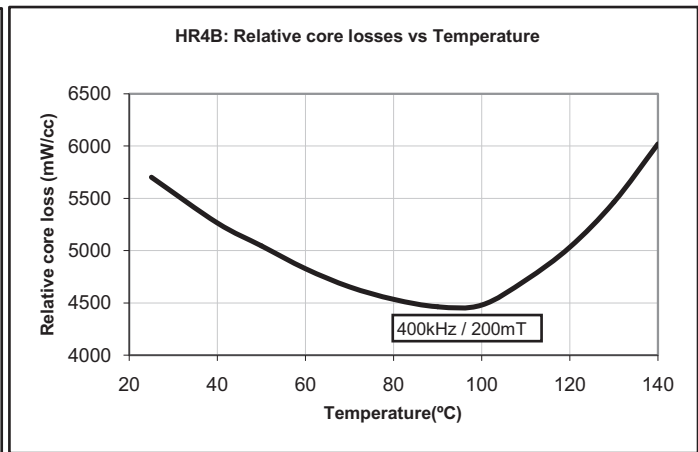
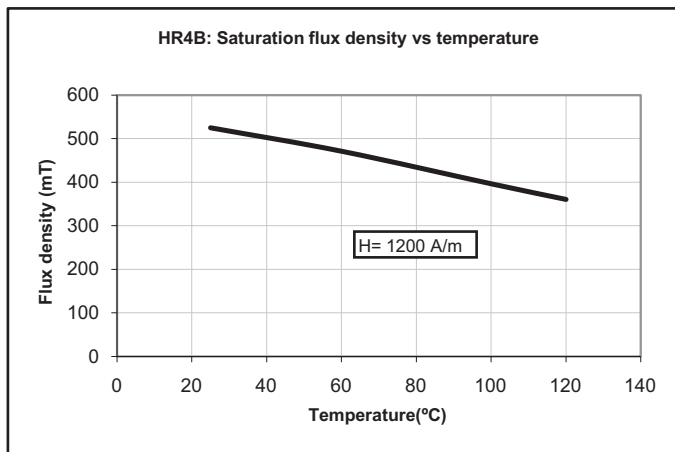
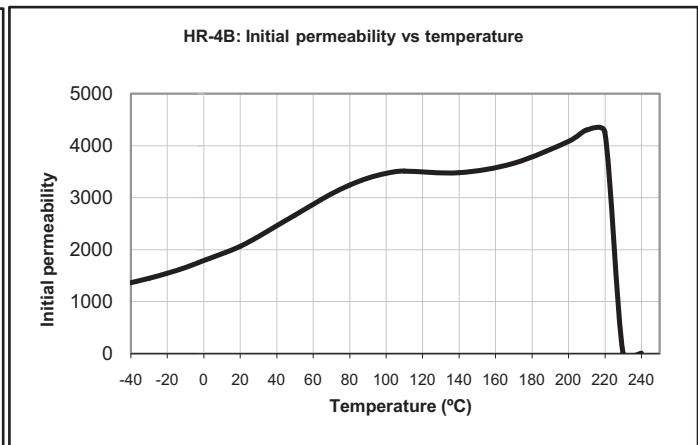
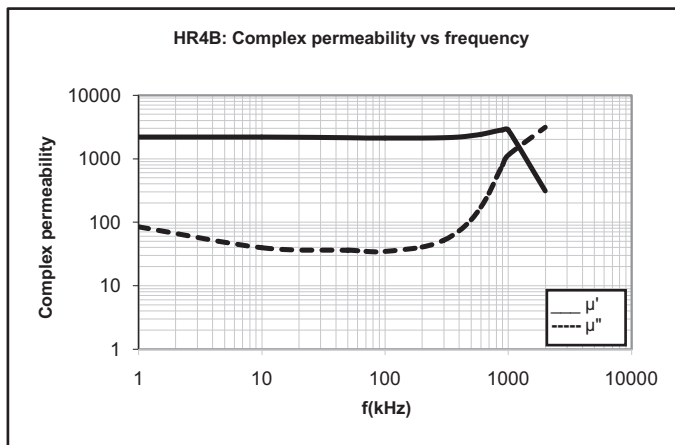

All measurements made on Toroid OD= 30mm, ID=20mm Ht=10mm.

HQ - 023 : High Q Inductors

Properties	Symbol	Unit	Test condition	Values
Initial permeability ($\pm 25\%$)	μ_i		0.1mT, 25°C	2300
Flux density (min)	Bs	mT	1200A/m, 25°C	420
			1200A/m, 100°C	290
Relative loss factor $\tan\delta/\mu_i$ (max)	$\tan\delta/\mu_i$	10^{-6}	0.25mT, 10kHz & 25°C	4
			0.25mT, 100kHz & 25°C	6
Coercive Field (max)	Hc	A/m	10kHz, 25°C	25
Curie Temperature (min)	Tc	°C		170
Density (min)	d	kg/m ³	25°C	4700
Temperature Coeff. of permeability (max)	α_F	$10^{-6}/K$	-40 to 80°C	3

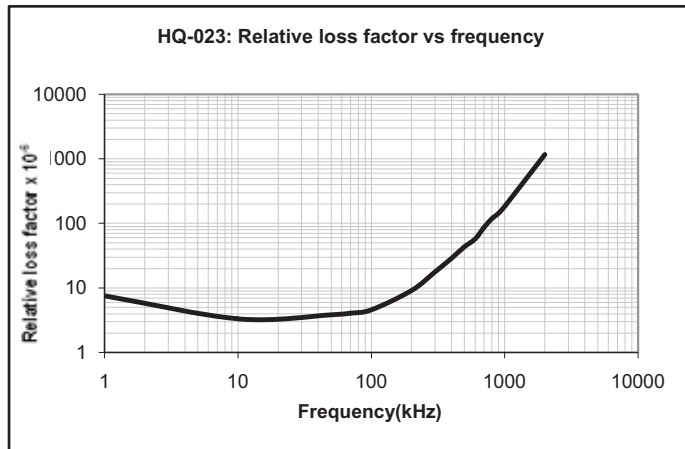
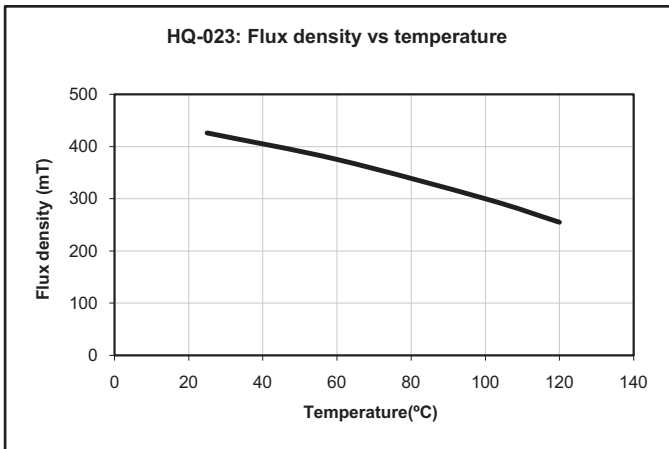
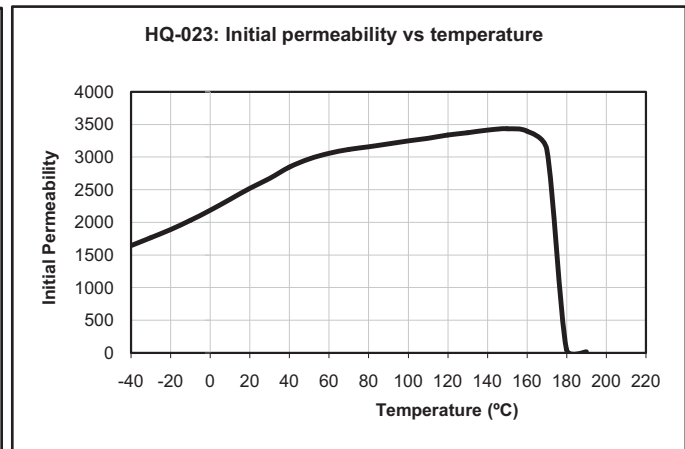
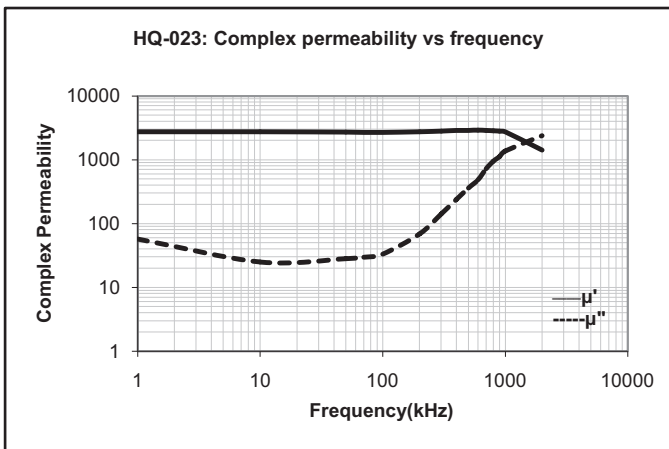

All measurements made on Toroid OD= 30mm, ID=20mm Ht=10mm.

Application of EE Cores

Small E Core

Impedance matching transformer
For Miniature Transformers
SMD Transformers

Large E Core

Common mode choke and broadband transformers
For SMPS
Energy storage chokes

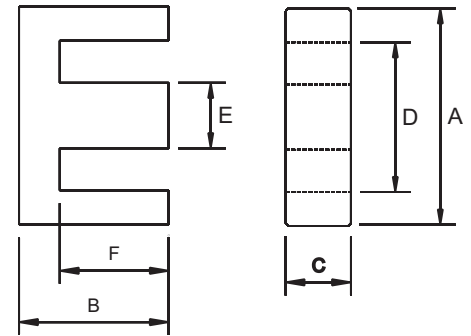

DIMENSIONS

Type	A(mm)	B(mm)	C(mm)	D(mm)	E (mm)	F (mm)	Le mm	Ae mm ²	Ve mm ³	AL VALUE (±25%)		Almin MGQ5C	HP 400	Approx wt gms/pair
										MSB-5S	MSB-7C			
E100/60/28	100 ^{+2.3} / _{-1.7}	60.00 ^{+0.0} / _{-1.1}	28.00 ^{+0.0} / _{-0.8}	72.00 ^{+2.4} / _{-0.0}	28.00 ^{+0.0} / _{-1.0}	46.00 ^{+1.7} / _{-0.0}	270	785	212000	---	5900	---	5900	2040
EE80/38/20	80.00 ± 1.6	38.1 ± 0.5	19.8 ± 0.4	59.1 Min	19.8 ± 0.4	28.2 ± 0.5	184	395	72300	---	6700	---	5000	360
EE70/33/32	70.5 ± 1	33.2 ^{+0.0} / _{-0.5}	32.00 ^{+0.0} / _{-0.8}	48.00 ^{+1.5} / _{-0.0}	22.00 ^{+0.0} / _{-0.7}	21.9 ^{+0.7} / _{-0.0}	149	683	102000	---	10800	---	8000	550
EE 65X33X28	65.00 ^{+1.5} / _{-1.2}	32.80 ^{+0.0} / _{-0.6}	27.40 ^{+0.0} / _{-0.8}	44.20 ^{+1.5} / _{-0.0}	20.00 ^{+0.0} / _{-0.7}	22.20 ^{+0.8} / _{-0.0}	147	532	78200	---	5550	---	---	400
EE 65X33X13	65.00 ^{+1.5} / _{-1.2}	32.80 ^{+0.0} / _{-0.6}	13.70 ^{+0.0} / _{-0.6}	44.20 ^{+1.5} / _{-0.0}	20.00 ^{+0.0} / _{-0.7}	22.20 ^{+0.8} / _{-0.0}	147	267	39350	6300	4500	---	---	191
EE 55X27X21	55.00 ^{+1.2} / _{-0.9}	27.80 ^{+0.0} / _{-0.6}	21.00 ^{+0.0} / _{-0.6}	37.50 ^{+1.2} / _{-0.0}	17.20 ^{+0.0} / _{-0.5}	18.50 ^{+0.8} / _{-0.0}	120	354	42500	7900	6000	---	---	214
EE 42X21X20	42.00 ^{+1.0} / _{-0.7}	21.20 ^{+0.0} / _{-0.4}	20.00 ^{+0.0} / _{-0.8}	29.50 ^{+1.2} / _{-0.0}	12.20 ^{+0.0} / _{-0.5}	14.80 ^{+0.7} / _{-0.0}	98	236	23100	6400	5200	---	---	113
EE 42X21X15	42.00 ^{+1.0} / _{-0.7}	21.20 ^{+0.0} / _{-0.4}	15.20 ^{+0.0} / _{-0.5}	29.50 ^{+1.2} / _{-0.0}	12.20 ^{+0.0} / _{-0.5}	14.80 ^{+0.7} / _{-0.0}	97	182	17650	5250	4000	---	---	86
EE 42X21X9	42.00 ^{+1.0} / _{-0.7}	21.20 ^{+0.0} / _{-0.4}	9.00 ^{+0.0} / _{-0.5}	29.50 ^{+1.2} / _{-0.0}	12.20 ^{+0.0} / _{-0.5}	14.80 ^{+0.7} / _{-0.0}	97	107	10400	2900	2300	---	---	51
EE 41X17X12	41.00 ^{+0.7} / _{-0.5}	17.50 ^{+0.6} / _{-0.0}	12.00 ^{+0.0} / _{-0.7}	28.50 ^{+0.7} / _{-0.0}	12.00 ^{+0.0} / _{-0.7}	10.25 ^{+0.6} / _{-0.0}	78.45	147	11563	5100	4100	---	---	56
EE 36X11X18	36.20 ± 0.5	18.00 ^{+0.5} / _{-0.0}	11.50 ^{+0.0} / _{-0.5}	24.50 ^{+1.2} / _{-0.0}	10.20 ^{+0.0} / _{-0.5}	12.00 ^{+0.5} / _{-0.0}	81	120	9670	4000	3100	---	---	50
EE 35X14X9	34.90 ± 0.7	14.50 ± 0.25	9.15 ± 0.25	25.75 ± 0.5	9.20 ± 0.25	10.00 ± 0.25	70	83	5870	3300	2650	---	---	30
EE 33X16X13	33.00 ± 0.5	16.50 ^{+0.5} / _{-0.0}	13.00 ^{+0.0} / _{-0.6}	23.40 min	10.00 ^{+0.0} / _{-0.6}	12.00 ^{+0.50} / _{-0.0}	76.6	118	8970	---	---	---	---	45
EE33X14X13	33.00 ± 0.5	14.00 ^{+0.5} / _{+0.0}	13.00 ^{+0.0} / _{-0.6}	23.40 min	10.00 ^{+0.0} / _{-0.6}	9.50 ^{+0.50} / _{-0.0}	67	118	7960	4700	3900	---	---	43
EE33X15X7	30.15 ± 0.35	15.20 ^{+0.5} / _{-0.35}	7.10 ^{+0.0} / _{-0.4}	20.00 min	7.05 ^{+0.0} / _{-0.4}	10.05 ^{+0.35} / _{-0.0}	66	57	3810	2730	2100	3300	---	21.6
EE 25X13X11	25.00 ^{+0.8} / _{-0.7}	12.5 ^{+0.5} / _{-0.0}	10.50 ± 0.25	17.50 ^{+0.8} / _{-0.0}	7.50 ^{+0.0} / _{-0.5}	8.95 ^{+0.5} / _{-0.0}	57	76	4400	3800	3050	---	---	23.1
EE 25X16X7	25.30 ^{+0.5} / _{-0.3}	15.70 ^{+0.6} / _{-0.0}	6.80 ^{+0.0} / _{-0.4}	19.20 min	6.50 ^{+0.3} / _{-0.25}	12.55 ^{+0.6} / _{-0.0}	73.5	42.0	3120	1685	---	---	---	15.4
EE 25X13X7	25.00 ^{+0.8} / _{-0.7}	12.80 ^{+0.0} / _{-0.5}	7.50 ^{+0.0} / _{-0.6}	17.50 ^{+0.8} / _{-0.0}	7.50 ^{+0.0} / _{-0.5}	8.70 ^{+0.5} / _{-0.0}	57.5	52.5	3020	2625	2100	2600	8000	16.5
EE 25X9X6	25.40 ± 0.7	9.70 ^{+0.0} / _{-0.4}	6.55 ^{+0.0} / _{-0.5}	19.00 ^{+1.2} / _{-0.0}	6.55 ^{+0.0} / _{-0.5}	6.30 ^{+0.4} / _{-0.0}	48	40	1950	2248	2000	2400	---	10
EE20X10X5	20.15 ± 0.55	10.20 ^{+0.0} / _{-0.4}	5.30 ^{+0.0} / _{-0.4}	12.80 ^{+0.6} / _{-0.0}	5.20 ^{+0.0} / _{-0.4}	6.30 ^{+0.4} / _{-0.0}	42.8	31.2	1340	1900	1560	2745	---	8
EE20X10X5-M	20.40 ^{+0.0} / _{-0.8}	10.10 ^{+0.0} / _{-0.4}	5.90 ^{+0.0} / _{-0.5}	14.10 ^{+0.8} / _{-0.0}	5.90 ^{+0.0} / _{-0.4}	7.00 ^{+0.4} / _{-0.0}	44.90	33.50	1500	---	---	---	1450	7.4
EE 19X8X5	19.30 ± 0.3	7.90 ± 0.2	5.20 ^{+0.0} / _{-0.5}	14.00 ± 0.3	5.20 ^{+0.0} / _{-0.5}	5.50 ± 0.2	37	22.20	822	---	---	1500	---	4.7
EE16X12X5	16.00 ± 0.4	12.40 ± 0.3	5.10 ^{+0.0} / _{-0.5}	12.0 ± 0.3	3.90 ± 0.3	10.40 ± 0.3	56.40	19.0	1060	---	---	---	---	5
EE16X8X5	16.00 ^{+0.7} / _{-0.5}	8.20 ^{+0.0} / _{-0.3}	4.70 ^{+0.0} / _{-0.4}	11.30 ^{+0.6} / _{-0.0}	4.70 ^{+0.0} / _{-0.3}	5.70 ^{+0.4} / _{-0.0}	37	20.10	750	1500	1100	1470	---	4
EE 12.65	12.65 ± 0.45	6.50 ^{+0.0} / _{-0.2}	3.70 ^{+0.0} / _{-0.3}	9.20 ± 0.3	3.70 ± 0.0	4.60 ^{+0.0} / _{-0.3}	29.7	29.6	367	---	---	800	1100	2

Application of EER ,EC , ETD , EED , EEH

For High inductance and low height
 Compact Transformers
 Compact winding design with low leakage currents
 Flyback converter for TV and monitors
 Switch mode power supplies
 Constant area of cross section
 along the magnetic path

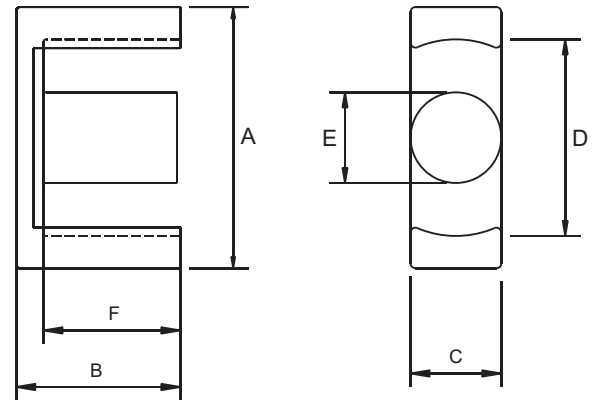

DIMENSIONS

Type	A(mm)	B(mm)	C(mm)	D(mm)	E (mm)	F (mm)
EC35	35.00 ± 0.5	22.6 ± 0.3	11.30 ± 0.3	25.60 +1.0/-0	11.30 ± 0.30	16.60 ± 0.30
EC40A	40.00 ± 0.5	24.2 ± 0.3	13.40 ± 0.3	29.00 +1.0/-0	13.30 ± 0.25	17.20 ± 0.30
EC40B	40.00 ± 0.5	22.8 ± 0.3	13.40 ± 0.3	29.00 +1.0/-0	13.30 ± 0.25	15.80 ± 0.30
EC40C	40.00 ± 0.5	22.5 ± 0.3	13.40 ± 0.3	29.00 +1.0/-0	13.30 ± 0.30	15.50 ± 0.30
EC42	42.00 ± 0.5	22.4 +0.4/-0.2	15.50 ± 0.3	29.40 Min	75.5 +0.2/-0.4	15.40 ± 0.30
EC90	90.00 ± 1.80	45.0 +0.65	30.00 ± 1.00	70.00 ± 1.50	30.00 ± 1.00	35.00 ± 0.50
EC120	120.00 ± 2.0	50.9 ± 0.5	30.00 ± 0.50	90.00 Min	30.00 ± 0.5	35.70 ± 0.50
EER0905	9.35 ± 0.15	2.45 ± 0.10	4.90 ± 0.1	7.50 Min	3.4 ± 0.10	1.675 ± 0.15
EER1105	10.85 ± 2.0	2.45 ± 0.10	5.90 ± 0.15	8.85 ± 0.2	4.125 ± 0.125	1.575 ± 0.10
EER1717	17.50 ± 0.35	8.50 ± 0.20	5.00 ± 0.2	13.60 ± 0.35	5.0 ± 0.15	6.30 ± 0.15
EER2622	25.50 ± 0.50	11.0 ± 0.20	7.50 ± 0.2	19.80 Min	7.5 ± 0.15	7.90 ± 0.20
EER28-A	28.50 +0.6/-0.5	17.3 +0/-0.6	11.4 ± 0.3	21.2 +1.0/-0	9.9 ± 0.30	12.25 +0.6/-0
EER28-B	28.50 ± 0.6	15.6 +0/-0.6	11.4 ± 0.3	21.2 +1.0/-0	9.9 ± 0.30	10.55 +0.6/-0
EER28-C	28.50 +0.6/-0.5	12.8 +0.6/-0	11.4 ± 0.3	21.2 +1.0/-0	9.9 ± 0.30	8.40 +0.6/-0
EER3019	30.00 ± 0.8	15.3 ± 0.2	11.3 ± 0.2	25.6 Min	11.3 ± 0.20	10.80 ± 0.3
EER42X20	42.15 ± 0.65	21.2 ± 0.2	19.6 ± 0.4	32.3 ± 0.5	17.3 ± 0.25	15.00 ± 0.5/0
EER42X17	42.00 +0.8/-0.5	25.7 ± 0.2	17.3 ± 0.3	30.3 ± 0.5	17.3 ± 0.25	18.2 ± 0.2
ETD29	30.60 +0.0/-0.6	16.0 +0/-0.4	9.8 +0/-0.6	22.0 +1.4/-0	9.8 +0/-0.6	10.70 +0.6/-0
ETD34	34.00 +0.0/-0.6	17.5 +0/-0.4	11.1 +0/-0.6	25.6 +1.4/-0	11.1 +0/-0.6	11.80 +0.5/-0
ETD39	38.90 +1.1/-0.7	20.0 +0/-0.4	12.8 +0/-0.6	29.3 +1.6/-0	12.8 +0/-0.6	14.20 +0.8/-0
ETD39	38.90 +1.1/-0.7	22.4 +0/-0.4	12.8 +0/-0.6	29.3 +1.6/-0	12.8 +0/-0.6	16.75 ± 0.5
ETD44	44.00 ± 1.0	22.3 ± 0.3	14.8 ± 0.4	33.8 ± 0.8	14.8 ± 0.40	16.50 ± 0.4
ETD49	48.50 +1.1/-0.9	24.9 +0/-0.4	16.7 +0/-0.6	36.0 ± 1.8/0	16.7 +0/-0.6	17.70 +0.8/-0.0
ETD54	54.5 ± 1.3	27.6 +0/-0.4	18.90 ± 0.4	41.2 ± 1.1	18.9 ± 0.4	20.2 ± 0.4
ETD5922	59.80 ± 1.4	31.2 +0/-0.4	22.1 +0/-0.9	43.6 +2.2/-0	22.1 +0/-0.9	22 +0.9/-0
EEH2820	28.00 ± 0.30	10.2 ± 0.2	11.9 ± 0.15	20.5 Min	8.5 ± 0.15	6.60 ± 0.1
EEH2929	29.30 ± 0.30	14.6 ± 0.20	11.6 ± 0.20	21.6 Min	8.4 ± 0.2	11.5 ± 0.2
EEH3311	33.00 ± 0.30	10.5 ± 0.2	13 ± 0.3	23.3 Min	10.5 ± 0.2	5.85 ± 0.15
EE4215	42.5 ± 0.5	21.4 ± 0.3	14.8 ± 0.3	31.15 Min	14.8 ± 0.3	15.4 ± 0.3

Type	Wt (gm)	Le (mm)	Ae (mm ²)	Ve (mm ³)	AL± 25%
EC35	55	93.8	107.0	10036	2650
EC40A	82	101.7	148.0	15050	3150
EC40B	79	93.8	143.0	13413	3200
EC40 C	77	93.6	148.0	13852	3450
EC42	102	98.8	194.0	19167	4100
EC90	656	216.0	624.0	134784	7100
EC120	975	26.00	7.730	205810	8000
EER0905	0.60	13.4	8.8	116	800
EER 1105	0.9	14.2	12.13	172	1400
EER 1717	4.40	41.2	20.0	827	930
EER 2622	11.20	54.1	44.3	2390	1880
EER28-A	34	78.3	85.0	6640	2850
EER28-B	35	64.0	85.0	5444	3200
EER28-C	25	54.5	83.8	4568	3200
EER3019	29	45.2	135.3	6100	5900
EER42X20	113	98.6	240.0	23664	3900
EER42X17	136	113.6	239.0	27180	4200
ETD29	28	70.4	76.0	5350	2100
ETD34	40	78.6	97.1	7632	2800
ETD39	61	92.1	125.0	11510	3200
ETD39	63	103.2	121.3	12531	3200
ETD44	94	103.0	173.0	17900	3700
ETD49	124	114.0	211.0	24050	4000
ETD 54	180	127	280	35500	5000
ETD5922	258	139.0	368.0	51500	6000
EEH2820	22	51.7	87.8	4688	3840
EEH2929	29.4	69.2	90	6220	3300
EEH3311	32.7	52.08	120.7	6289	3200
EER42/15	85	100.12	166	16591	---

Application of EI cores

Transformers for SMPS

Impedance matching Transformers

Miniature and SMD transformers

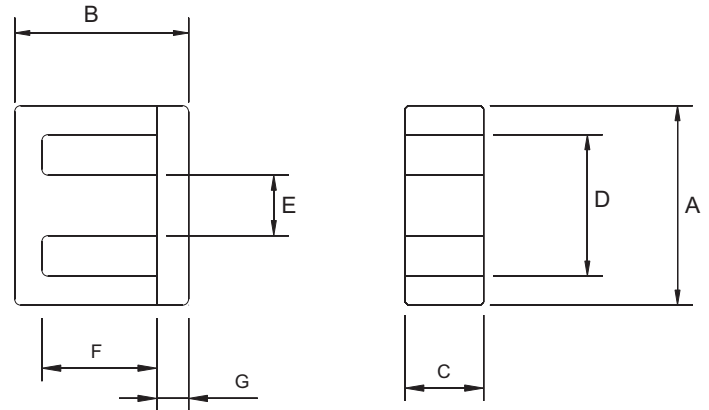

DIMENSIONS

Type	A(mm)	B(mm)	C(mm)	D(mm)	E (mm)	F (mm)	G(mm)
EI1614	16 ± 0.3	14.5 ± 0.5	4.8 +0.1 -0.2	11.7 Min	3.8 ± 0.2	10.4 ± 0.2	2 ± 0.2
EI1916	19.2 ± 0.4	15.2 +0.8 -0.4	5.50 +0.01 -0.2	14 Min	5.1 +0/-0.50	10.5 ± 0.3	2.4 ± 0.2
EI2218	22.00 ± 0.6	19 ± 0.5	6.00 +0.00 -0.50	15.6 Min	6.1 +0/-0.50	11 ± 0.3	4.00 ± 0.3
EI2519	25.00 +0.50 -0.30	19.30 +0.70 -0.30	6.50 ± 0.30	17.80 Min	6.50 ± 0.25	13.00 +0.40 -0.00	3.30 ± 0.30
EI2820	28.00 ± 0.50	20.20 +0.30 -0.80	11.00 +0.00 -0.60	18.60 Min	7.50 +0.00 -0.60	12.20 +0.50 -0.00	3.50 ± 0.30
EI2820 A	28.00 ± 0.50	20.80 ± 0.60	11.00 +0.20 -0.30	18.60 Min	7.50 +0.00 -0.60	12.80 ± 0.30	3.50 ± 0.30
EI3026	30.00 +0.70 -0.20	26.50 +0.60 -0.00	11.00 +0.0 -0.70	20.00 +0.70 -0.00	11.00 +0.00 -0.70	16.00 +0.60 -0.00	5.50 ± 0.20
EI3329	33.00 ± 0.50	28.75 ± 0.50	13.00 +0.00 -0.60	23.40 Min	10.00 +0.00 -0.60	19.00 +0.50 -0.00	5.00 ± 0.30
EI3530	35.00 +0.80 -0.50	29.60 +0.90 -0.20	12.00 +0.00 -0.60	25.30 Min	10.30 +0.00 -0.60	18.30 +0.60 -0.00	5.50 ± 0.20
EI4035	40.00 ± 0.50	35.00 +0.80 -0.30	12.00 +0.00 -0.70	27.50 +0.70 -0.00	12.00 +0.00 -0.70	20.20 +0.50 -0.00	7.50 ± 0.30
EI5042	50.10 ± 1.00	42.05 +0.75 -0.25	14.70 ± 0.40	34.50 +0.70 -0.00	14.60 ± 0.40	24.50 +1.00 -0.00	9.00 ± 0.25
EI7026	70.00 ± 1.50	56.00 ± 1.00	19.50 ± 0.50	50.00 ± 0.50	19.50 ± 0.50	35.50 ± 0.50	10.50 ± 0.50

EFFECTIVE PARAMETERS

Type	Wt set Gm	Le mm	Ae mm ²	Ve mm ³	AL± 25%	
					MSB7C	MSB5S
EI1614	3.70	35.3	190	660	385	400
EI1916	4.7	38.16	25.5	976	600	670
EI2218	8	41	36	1476	1600	1600
EI2519	10.20	47.1	42.0	1980	2100	2500
EI2820	22.00	48.9	86.0	4140	5000	
EI2820 A	23.00	49.5	86.5	4195		6500 min InMGQ5C
EI3026	34.00	58.6	110.0	6440	4000	3900
EI3329	42.00	67.5	119.0	8040	3700	5200
EI3530	41.50	67.3	120.0	8076	4000	4800
EI4035	60.30	77.1	147.0	11370	4500	5400
EI5042	110.90	95.4	226.4	21599	1500	1500
EI7026	257.40	133.0	390.0	51870	1500	2010

AL Values : nH ±25% 1KHz 0.1V 100Ts

Application of EFD cores

For DC- DC Converter

For flat transformers of Lower center leg

Optimized cross section of Legs

Good thermal response in case of Flat type EFD
due optimised distribution of Cross section

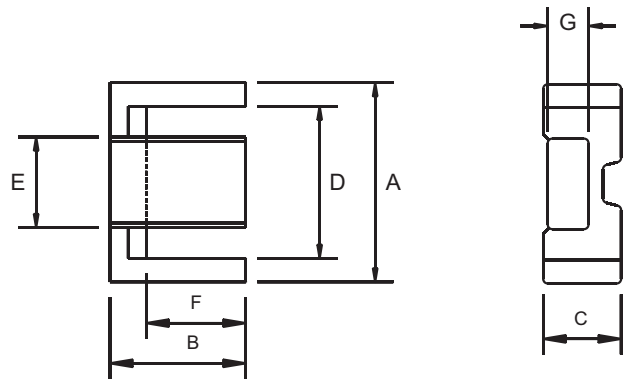

DIMENSIONS

Type	A(mm)	B(mm)	C(mm)	D(mm)	E (mm)	F (mm)	G(mm)
EFD1010	10.50 ± 0.3	5.20 ± 0.10	2.70 ± 0.10	7.65 ± 0.25	4.55 ± 0.15	3.75 ± 0.15	1.45 ± 0.05
EFD1212	12.50 ± 0.10	6.20 ± 0.10	3.50 ± 0.10	9.00 ± 0.25	5.40 ± 0.15	4.55 ± 0.15	2.00 ± 0.10
EFD1515	15.00 ± 0.40	7.50 ± 0.15	4.65 ± 0.15	11.00 ± 0.35	5.30 ± 0.15	5.50 ± 0.25	2.40 ± 0.10
EFD2020	20 ± 0.55	10.00 ± 0.15	6.65 ± 0.15	15.40 ± 0.50	8.90 ± 0.20	7.70 ± 0.25	3.60 ± 0.15
EFD2525	25.00 ± 0.65	12.50 ± 0.15	9.10 ± 0.20	18.70 ± 0.60	11.40 ± 0.20	9.30 ± 0.25	5.20 ± 0.15
EFD3030	30.00 ± 0.8	15.00 ± 0.20	9.10 ± 0.20	22.40 ± 0.75	14.60 ± 0.25	11.20 ± 0.30	4.90 ± 0.15
EFD4030	40.70 ± 0.8	15.00 ± 0.15	8.00 ± 0.25	28.70 ± 0.60	16.00 ± 0.30	10.00 ± 0.15	5.00 ± 0.15

EFFECTIVE PARAMETERS

Type	Wt set gm	Le mm	Ae mm ²	Ve mm ³	AL ± 25%
					HP400
EFD1010	0.9	23.7	7.2	171	585
EFD1212	1.80	28.5	11.4	325	825
EFD1515	2.8	34.0	15.0	510	950
EFD2020	7.20	47.0	31.0	1460	1300
EFD2525	16	57.0	58.0	3300	2200
EFD3030	24	38.0	69.0	4700	2100
EFD4030	31.00	70.9	82.2	5830	2450

AL Values : nH ± 25% 1KHz 0.1V 100Ts

Application od EP cores

For power application
 Excellent properties for broadband transformers
 For Transformers featuring
 high Inductance and Low height
 Excellent magnetic sheilding

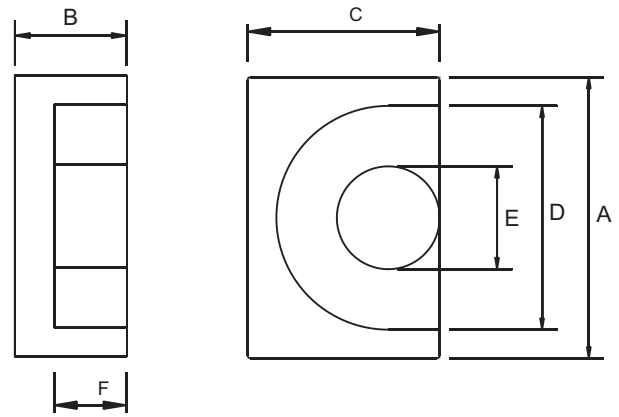

DIMENSIONS

Type	A(mm)	B(mm)	C(mm)	D(mm)	E (mm)	F (mm)
EP5	6.00 ± 0.15	2.80 ± 0.05	3.80 ± 0.10	4.4 ± 0.15	1.70 ± 0.10	200 ± 0.10
EP7	9.40 + 0.00 - 0.40	3.75 ± 0.00 - 0.10	6.50 + 0.00 - 0.30	7.2 ± 0.40 - 0.00	3.40 + 0.00 - 0.20	250 + 0.20 - 0.10
EP10	11.50 ± 0.30	5.10 ± 0.10	7.60 ± 0.20	9.8 ± 0.20	3.30 ± 0.15	3.70 ± 0.10
EP13	12.80 + 0.00 - 0.60	6.50 ± 0.00 - 0.15	9.00 + 0.00 - 0.40	9.7 ± 0.60 - 0.00	4.50 + 0.00 - 0.30	4.50 + 0.20 - 0.00
EP17	18.00 ± 0.4	8.4 ± 0.1	11.00 ± 0.3	12.0 ± 0.4	5.7 ± 0.18	5.70 ± 0.15
EP20	24.00 ± 0.50	10.7 ± 0.1	15.00 ± 0.4	16.5 ± 0.4	8.8 ± 0.25	7.20 ± 0.15

EFFECTIVE PARAMETERS

Type	Wt set gm	Le mm	Ae mm ²	Ve mm ³	AL ± 25%
					HP400
EP5	0.50	9.7	3.0	28.7	400
EP7	1.40	15.7	10.3	162.0	1100
EP10	2.80	19.2	11.3	217.0	1100
EP13	4.7	24.2	19.5	474.0	1600
EP17	12	29.5	33.7	999.0	2200
EP20	27	41.1	78.7	3230.0	3850

AL Values : nH ± 25% 1KHz 0.1V 100Ts

Application of EPC cores

- For DC- DC Converter
- For flat transformers of Lower center leg
- Optimized cross section of Legs
- EMI Suppression Chokes
- Good thermal response

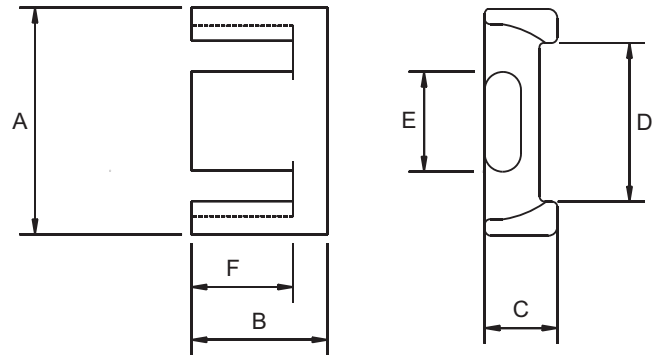

DIMENSIONS

Type	A(mm)	B(mm)	C(mm)	D(mm)	E(mm)	F (mm)
EPC1313	13.20 ± 0.25	6.60 ± 0.20	4.60 ± 0.15	8.30 Min	5.6 ± 0.15	4.50 ± 0.20
EPC1716	17.50 ± 0.30	8.55 ± 0.20	6.00 ± 0.20	12 ± 0.50	7.70 ± 0.15	6.05 ± 0.20
EPC1920	19.10 ± 0.40	9.75 ± 0.20	6.00 ± 0.15	13.10 Min	8.50 ± 0.15	7.25 +0.2/-0.1
EPC2228	21.90 ± 0.30	14.5 ± 0.20	7.30 ± 0.15	14.70 Min	9.5 ± 0.15	11.55 ± 0.15
EPC2225	21.90 ± 0.30	14.20 ± 0.20	7.30 ± 0.15	9.50 ± 0.15	14.70 Min	11.55 ± 0.15
EPC2525	25.40 ± 0.50	12.50 ± 0.25	8.00 ± 0.15	18.35 ± 0.4	10.5 ± 0.25	9.00 ± 0.20
FQKT16.5	16.50 ± 0.30	12.0 ± 0.20	8.70 ± 0.20	5.70 ± 0.10	9.00 ± 0.50	8.60 +0.25/-0.0
FQKT17.4	17.40 ± 0.3	11.8 ± 0.10	8.7 ± 0.20	5.70 ± 0.15	10.0 ± 0.50	8.70 ± 0.15
FQKT18	18.00 ± 0.3	11.8 ± 0.20	8.7 ± 0.20	5.70 ± 0.15	10.8 ± 0.50	8.70 ± 0.15

EFFECTIVE PARAMETERS

Type	Wt / set	Le	Ae	Ve	Al ± 25%
	gm	mm	mm ²	mm ³	Hp400
EPC1313	0.92	19.28	8.36	161.23	870
EPC1716	4.62	40.2	22.8	917	1050
EPC1920	5.20	46.1	22.7	1047	900
EPC2228	12.84	63.15	36.9	2330	1300
EPC2225	12.40	63.1	40.2	2530	1390
EPC2525	12.16	52.73	39.18	2867	1500
FQKT16.5	9.2	44.1	31.8	1380	1100
FQKT17.4	9.50	48.0	32.0	1520	1150
FQKT18	9.80	48.0	32.3	1550	1300

AL Values : nH ± 25% 1KHz 0.1V 100Ts

Application of PQ cores

Compact Transformers
 Low distortion broadband transmission at low signal
 DC/DC Converters

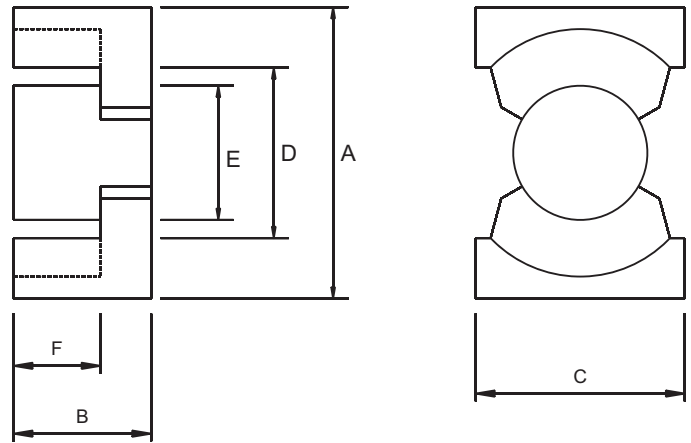

DIMENSIONS

Type	A(mm)	B(mm)	C(mm)	D(mm)	E (mm)	F (mm)
PQ2020	21.3 ± 0.4	10.10 ± 0.1	14.00 ± 0.40	18.00 ± 0.40	8.80 ± 0.20	7.15 ± 0.20
PQ2620	26.50 ± 0.45	10.075 ± 0.125	19.00 ± 0.45	22.50 ± 0.45	12.00 ± 0.20	5.75 ± 0.15
PQ2625	26.50 ± 0.45	12.50 ± 0.25	19.00 ± 0.5	22.50 ± 0.45	12.00 ± 0.20	8.15 ± 0.25
PQ3220	33.00 ± 0.50	10.55 ± 0.20	22.00 ± 0.5	27.50 ± 0.50	13.45 ± 0.25	6.05 ± 0.20
PQ3230	33.00 ± 0.50	15.15 ± 0.15	22.00 ± 0.5	27.50 ± 0.50	13.50 ± 0.25	10.65 ± 0.20
PQ3535	36.10 ± 0.60	17.35 ± 0.125	26.00 ± 0.5	32 ± 0.5	14.4 ± 0.25	12.5 ± 0.15
PQ4040	41.5 ± 0.90	20.00 ± 0.15	28.00 ± 0.6	37.00 ± 0.60	14.90 ± 0.30	14.80 ± 0.20
PQ5050	51.00 ± 0.70	25 ± 0.25	32.00 ± 0.6	44.00 ± 0.70	20.00 ± 0.35	18.05 ± 0.30

EFFECTIVE PARAMETERS

Type	Wt / set gm	Le mm	Ae mm ²	Ve mm ³	AL HP400
PQ2020	14	45.7	62.6	2850	2800
PQ2620	30.00	45.3	19.5	472.0	1600
PQ2625	36.0	55.5	33.7	999.0	4450
PQ322D	43	56.7	170.0	9639.0	6360
PQ323D	62	74.7	167.0	12500	4770
PQ3535	80.0	87.9	196.0	17228.0	5370
PQ4040	95.0	101.9	201.0	20482.0	4900
PQ5050	195	113.0	328.0	37100	6300

Application of RM cores

Compact design
 Low distortion broadband
 transmission at low signal
 DC/DC Converters

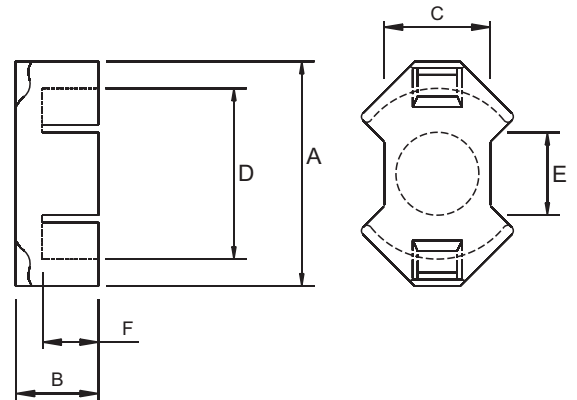

Type	A(mm)	B(mm)	C(mm)	D(mm)	E (mm)	F (mm)
RM4	11.00 + 0.00 - 0.15	5.20 ± 0.05	4.60 + 0.00 - 0.20	7.95 + 0.40 - 0.00	3.9 + 0.00 - 0.20	3.5 + 0.20 - 0.00
RM5	14.9 max	5.20 ± 0.05	6.80 + 0.00 - 0.40	10.20 + 0.40 - 0.00	4.9 + 0.00 - 0.20	3.15 + 0.20 - 0.00
RM6	17.9 + 0.0 - 0.7	6.20 ± 0.05	8.20 + 0.00 - 0.40	12.40 + 0.50 - 0.00	6.40 + 0.00 - 0.20	4.00 + 0.20 - 0.00
RM8	23.20 + 0.0 - 0.90	8.20 ± 0.05	11.00 + 0.00 - 0.50	17.00 + 0.60 - 0.00	8.55 + 0.00 - 0.30	5.40 + 0.20 - 0.00
RM10	28.50 + 0 - 1.3	9.30 ± 0.05	13.50 + 0.00 - 0.50	21.20 + 0.90 - 0.00	10.90 + 0.00 - 0.40	6.20 + 0.30 - 0.00
RM12	37.40 + 0 - 1.3	12.25 ± 0.05	16.10 + 0.00 - 0.50	25.00 + 1.00 - 0.00	12.8 + 0.00 - 0.40	8.40 + 0.30 - 0.00
RM14	42.20 + 0 - 1.4	15.05 ± 0.05	18.00 + 0.00 - 0.60	29.00 + 1.20 - 0.00	15.00 + 0.00 - 0.60	10.40 + 0.30 - 0.00

EFFECTIVE PARAMETERS

Type	Wt set gm	Le mm	Ae mm ²	Ve mm ³	AL HP400
RM4	1.7	23.2	13.8	322	1070
RM5	3.3	22.1	23.8	526	1800
RM6	5.0	28.6	36.6	1050	2350
RM8	12.40	38.0	64.0	2430	3300
RM10	22.00	44.0	98.0	4310	4340
RM12	45	56.0	150.0	8400	5400
RM14	74	69.0	206.0	14100	6100

AL Values : nH ± 25% 1KHz 0.1V 100Ts

Application of Planar cores

- Low profile core
- High AL Value
- High core surface to volume ratio
- Excellent thermal performance
- High output currents at low output voltage
- Good EMC characteristics

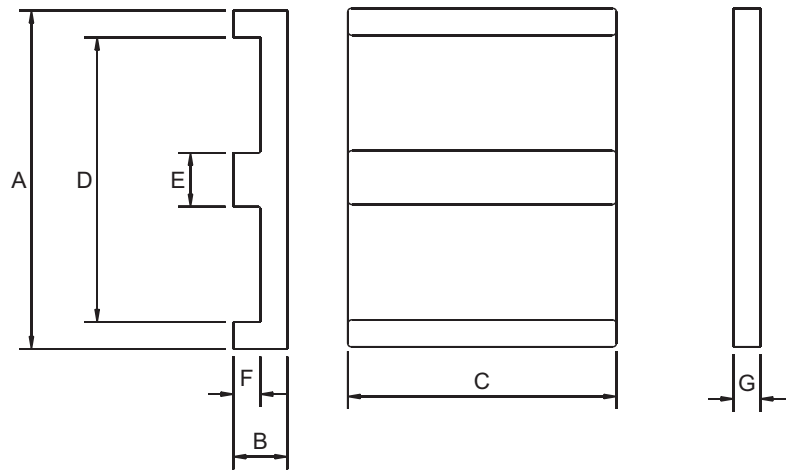

DIMENSIONS

Type	A(mm)	B(mm)	C(mm)	D(mm)	E (mm)	F (mm)	G(mm)
PEE1407	14.00 ± 0.30	3.50 ± 0.10	5.00 ± 0.10	11.0 ± 0.25	3.00 ± 0.05	2.00 ± 0.10	---
PEE1808	18.00 ± 0.35	4.00 ± 0.10	10.00 ± 0.20	14.00 ± 0.30	4.00 ± 0.10	2.00 ± 0.10	---
PEE2211	21.80 ± 0.40	5.7 ± 0.1	15.80 ± 0.30	16.80 ± 0.40	5.00 ± 0.10	3.20 ± 0.10	---
PEI1405	14.00 ± 0.30	3.5 ± 0.10	5.00 ± 0.10	11.00 ± 0.25	3.00 ± 0.05	2.00 ± 0.10	1.50 ± 0.05
PEI1806	18.00 ± 0.35	4.00 ± 0.10	10.00 ± 0.20	14.00 ± 0.30	4.00 ± 0.10	2.00 ± 0.10	2.00 ± 0.05
PEI2208	21.8 ± 0.40	5.70 ± 0.10	15.80 ± 0.30	16.80 ± 0.40	5.00 ± 0.10	3.20 ± 0.10	2.50 ± 0.05
PEE6420	64 ± 1.30	10.20 ± 0.15	50.80 ± 1.10	53.8 ± 1.10	10.2 ± 0.20	5.10 ± 0.15	---

EFFECTIVE PARAMETERS

Type	Wt set gm	Le mm	Ae mm ²	Ve mm ³	AL±25% HP400
PEE1407	1.20	20.7	14.3	300.0	1280
PEE1808	4.80	24.30	39.3	960	2880
PEE2211	13	32.50	78.3	2550	4800
PEI1405	1.10	16.70	14.50	240	1440
PEI1806	4.10	20.50	39.50	800	3200
PEI2208	10.50	26.10	78.50	2040	5520
PEE6420	200	79.90	519.00	40700	14000

AL Values : nH ± 25% 1KHz 0.1V 100Ts

Application of U Cores

- Pulse and High Voltage Transformer
- Line Deflection transformers
- Energy storage chokes
- common chokes
- Suppression for Line Filter

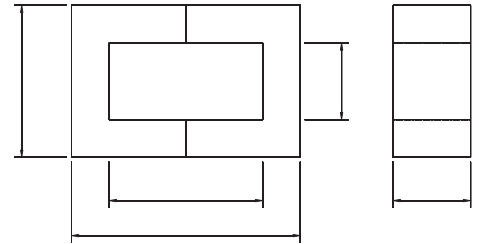

DIMENSIONS

Type	A(mm)		B(mm)		C(mm)		D(mm)		E (mm)	
UU 10	10.00	± 0.25	14.40	± 0.4	3.00	+0.0/-0.4	4.30	+ 0.4/-0.2	8.60	± 0.6
UU 10.5	10.50	± 0.25	15.80	± 0.4	5.35	± 0.25	5.30	+ 0.4/-0.0	10.60	± 0.3
UU 1414	14	± 0.3	14.2	± 0.3	2.7	± 0.2	8.4	Ref	8.4	± 0.4
UU 15	15.20	± 0.7	23.4	+0/-1.20	6.70	+0/-0.5	5.20	± 0.3	11.40	+ 1.4/-0
UU 16	16.00	± 0.7	21.20	± 0.6	6.00	± 0.25	7.00	± 0.3	12.00	± 0.7
UU 20	20.00	± 0.3	36.00	± 0.5	6.00	± 0.2	8.00	± 0.25	24.00	± 0.5
UU 21	21.00	± 0.6	31.60	+0/-1.20	7.50	± 0.25	6.00	± 0.4	16.60	+ 1.0
UU 23	23.00	± 0.6	32.00	+0/-1.20	7.55	± 0.25	8.00	± 0.2	16.50	+ 1.0
UU 4628	46	± 1	79	± 0.5	28	± 0.8	17.5	min	51	± 1.0
UU 8025	80	± 1.6	98	± 1.0	20	± 0.5	40	± 0.8	58	± 1.0
UU 93X16	93.00	± 1.8	152.0	± 1.0	16.0	± 0.40	36.2	± 1.20	96.00	± 1.8
UU 93X30	93.00	± 1.8	152.0	± 1.0	30.0	± 0.60	36.2	± 1.2	96.00	± 1.8
UU 101	101.6	± 2.0	114.3	± 0.8	25.4	± 0.76	50.8	± 1.0	63.50	± 1.5
UU 126	126.00	± 2.0	89.0	± 1.0	20.0	± 0.60	70.0	± 1.0	62.00	Min
I 101X25.4	101.59	± 2.00	25.4	± 0.76	25.4	± 0.76	---		---	
I 93x30	93.00	± 1.80	28.0	± 0.50	30.0	± 0.60	---		---	
I 126	126.00	± 2.00	27.5	± 0.50	20.0	± 0.60	---		---	

EFFECTIVE PARAMETERS

Type	Wt	Le cm	Ae cm ²	Ve cm ³	AL±25%		
					MSB5S	MGQ5C	MSB7C
UU 10	1.4	3.48	0.086	0.30	---	720	---
UU 10.5	2.81	3.75	0.139	0.521	900	1000 min	---
UU 1414	480	0.4	1.6	42.4	7.6	322	1540
UU 15	8.70	4.80	0.320	1.536	1800	2058 min	---
UU 16	7.60	5.21	0.275	1.433	---	2175 min	---
UU 20	15.5	8.80	0.36	2.98	---	1700 min	---
UU 21	20.40	6.80	0.560	3.800	2450	2300 min	---
UU 23	22.40	7.40	0.610	4.514	2065	---	---
UU 4628	---	630	192.6	645	130450	---	7900
UU 8025	---	258	400 mm ²	103200	159.00	---	3000
UU 93X16	---	955.0	35.50	8.4	298	---	5300
UU 93X30	---	1050	30.84	6.452	198.965	---	5400
UU 101	---	1340.0	48.00	5.600	2.68.800	---	3050
UU 126	---	48.00	5.60	269	---	---	3000
I 101 x 25.4	---	24.5	6.45	158.00	---	---	6500
I 93x30	---	21	8.36	17.5	---	---	8500
I 126	---	35.4	5.6	198	---	---	3800

Application of FBT

Storage choke
 Interference suppression component
 High saturation reponse,
 low loss and high Tc

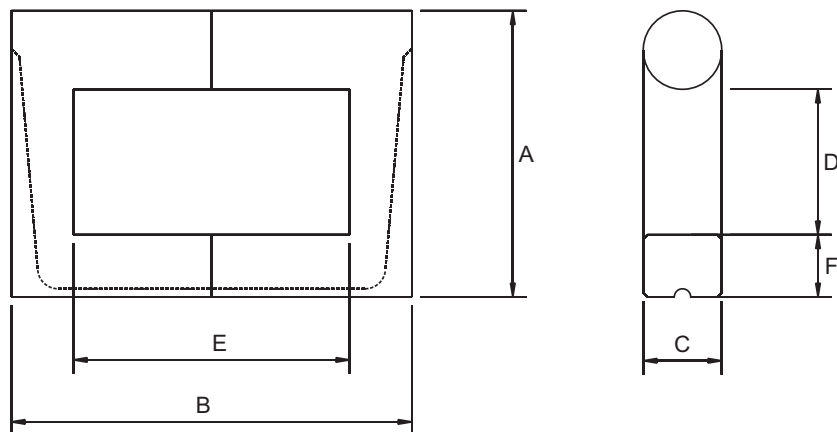

DIMENSIONS

PART NO.	A(mm)	B(mm)	C(mm)	D(mm)	E (mm)	F (mm)	Le Cm	Ae Cm ²	Ve Cm ³	Approx. wt. gms / pair
FUT 3544	34.75 ± 0.5	44.50 ± 0.6	11.50 + 0.5 - 0.3	13.10 min	25.50 ± 0.6	9.50 ± 0.25	10.80	1.040	11.318	55.0
FUT 3555	35.40 + 0.5	55.0 0.60	13.00 ± 0.3	11.90 min	35.00 ± 0.6	10.00 ± 0.3	12.852	1.287	16.542	84.0
FUT 3569	35.15 ± 1.0	68.60 ± 0.6	12.80 + 0.5 - 0.3	13.05 min	48.00 ± 0.6	9.30 ± 0.4	15.770	1.173	18.498	96.0
FUT 3570	35.00 + 0.50	71.00 0.60	12.50 ± 0.25	13.50 min	51.00 ± 0.6	8.50 ± 0.3	16.20	1.09	17.789	91.0
FUT 3859	38.00 ± 0.5	59.00 ± 0.6	14.00 + 0.5 - 0.3	12.00 min	37.00 ± 0.6	11.50 ± 0.25	13.600	1.522	20.67	105.5
FUT 3863 13 mm Ø	38.00 + 0.5	64.00 ± 0.6	13.00 + 0.5 - 0.3	13.80 min	42.60 ± 0.6	10.70 ± 0.2	14.923	1.333	19.893	98.0
FUT 3863 14 mm Ø	38.00 ± 0.5	62.90 ± 0.60	14.00 + 0.5 - 0.3	12.00 min	40.70 ± 0.5	11.50 ± 0.25	14.350	1.515	21.750	112.0
FUT 3872	38.90 ± 0.5	73.00 ± 0.5	14.00 ± 0.3	12.95 min	51.00 ± 0.5	11.30 ± 0.3	16.50	1.52	25.196	124.0
FUT 3956	38.75 ± 0.5	56.40 ± 0.6	13.50 ± 0.25	14.25 min	34.40 ± 0.6	10.50 ± 0.25	13.210	1.380	18.240	92.0
FUT 4062	40.05 ± 0.5	62.20 ± 0.60	14.50 + 0.5 - 0.3	13.55 min	40.20 ± 0.6	11.50 ± 0.3	14.610	1.597	23.335	116.0
FUT 4363	42.75 + 0.5 - 0.6	66.50 ± 0.6	14.00 ± 0.3	16.75 min	40.00 ± 0.6	11.50 nom	15.240	1.540	23.460	120.0
FUT 4366	42.75 + 0.5 - 0.6	66.50 ± 0.6	14.00 ± 0.3	16.75 min	43.50 + 0.6	11.50 nom	15.960	1.540	24.570	126.0
FUT 4374	42.75 + 0.5 - 0.6	74.00 ± 0.6	14.00 ± 0.3	16.65 min	51.00 + 0.6	11.5 ± 0.3	17.52	1.540	27.065	134.0
FUT 4676	46.00 ± 0.5	76.20 ± 0.6	15.00 ± 0.3	18.40 min	52.00 ± 0.6	12.00 nom	18.210	1.710	31.139	160
FUT 4270	42.00 ± 0.5	33.50 ± 0.6	13.00 ± 0.3	13.00 min	13.00 ± 0.6	23.10 ± 0.3	15.20	1.36	20.66	100
FUT 3867	38.50 ± 0.5	69.40 ± 0.3	14.75 ± 0.3	15.00 min	15.00 ± 0.6	22.70 ± 0.3	17.8	1.62	28.72	140

These cores are available in MSB 7C & MSB 5F(H) grade.

Application of Ferrite Bars

For Induction Heating
 For Tyre pressure and
 Keyless Entry application
 For EMI Absorption

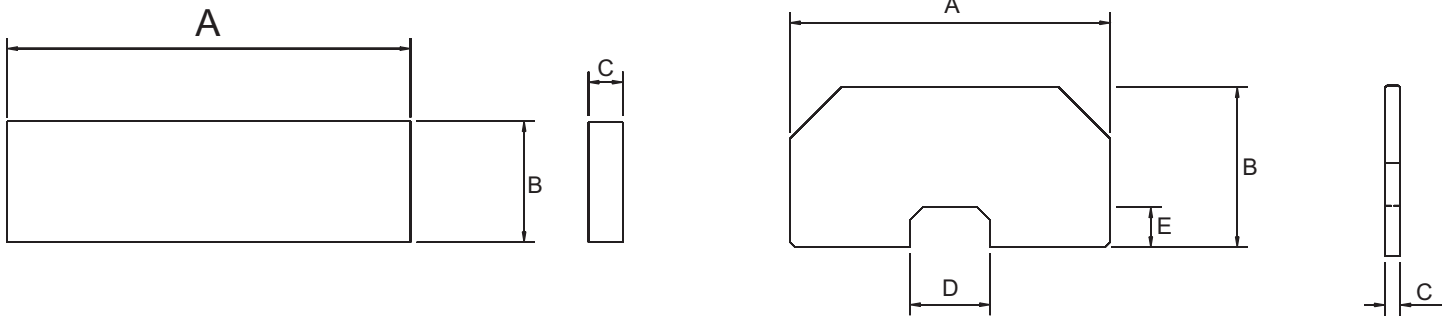

DIMENSIONS

Type	A(mm)	B(mm)	C(mm)	D(mm)	E (mm)	WT/ set
Fbar 79/23/4	79 ± 0.8	23.5 ± 0.5	4 ± 0.2	---	---	36
Fbar 79/23/4	79 ± 0.8	19 ± 0.4	4 ± 0.2	---	---	29
Fbar 64/10/3	64.50 ± 0.70	9.80 ± 0.20	3.50 ± 0.50	---	---	10.00
Fbar 64/23/4	64.50 ± 0.70	23.50 ± 0.50	3.95 ± 0.20	---	---	29.00
Fbar 62/31/4	62.00 ± 0.60	31.00 ± 0.50	4.00 ± 0.20	---	---	37.50
Fbar 60/23/4	60.00 ± 0.50	23.00 ± 0.40	4.00 ± 0.20	---	---	27.00
Fbar 55/23/4	55.00 ± 1.00	23.50 ± 0.50	3.95 ± 0.20	---	---	25.00
Fbar 42/23/4	42.00 ± 0.80	23.50 ± 0.50	4.3 ± 2.0	---	---	20.5
Fbar 36/28/4	36.00 ± 0.60	28 ± 0.50	4.00 ± 0.20	---	---	20.00
Fbar 32/26/4	32.00 ± 0.50	26.00 ± 0.50	4.00 0.20	---	---	16.30
CFbar 88/44/4	88.00 ± 1.20	44.00 ± 0.60	4.00 ± 0.40	26.00 ± 0.60	13.00 ± 0.40	64.00
CFbar 62/31/4	62.00 ± 0.70	31.00 ± 0.50	4.00 ± 0.20	16.00 ± 0.30	8.00 ± 0.40	38.00

Application of Toroid

- Common mode choke
- Interference suppression for line filter
- Signal transformer
- Highest permeability for volume
- Gapped Torroid

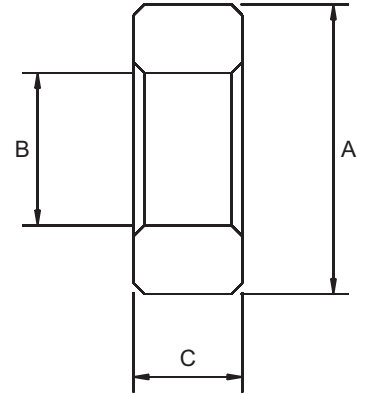
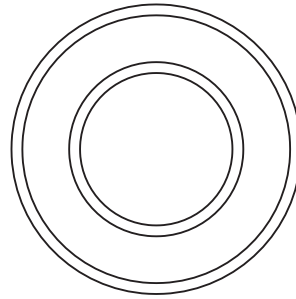

DIMENSIONS

TYPE	ØA(mm)	ØB(mm)	C(mm) Cm ²	Le Cm ²	Ae Cm ²	Ve Cm ²	AL (±25%) MSB-5S	AL ^{min} MGQ5C	Approx wt. gms/pc
T 10.0	10.0 ± 0.6	6.0 ± 0.2	3.0 ± 0.3	2.51	0.06	0.15	900	1200	0.72
T 10.0	10.0 ± 0.6	6.0 ± 0.2	4.0 ± 0.3	2.51	0.08	0.20	1200	1600	1.0
T 12.5	12.5 ± 0.4	7.5 ± 0.4	5.0 ± 0.3	3.14	0.13	0.39	2000	1870	1.92
T 13.3	13.3 ± 0.3	8.3 ± 0.3	5.2 ± 0.6	3.39	0.13	0.43	1345	1680	2.1
T 15.2	15.2 ± 0.5	7.6 ± 0.4	6.7 ± 0.3	3.58	0.25	0.91	---	3300	4.4
T 16.0	16.0 ± 0.4	10.0 ± 0.4	6.3 ± 0.3	4.08	0.19	0.77	1745	2000	3.7
T 17.5	17.5 ± 0.6	11.5 ± 0.4	8.0 ± 0.3	4.56	0.24	1.10	1980	2320	5.3
T 19.0	19.0 ± 0.5	11.0 ± 0.4	8.0 ± 0.3	4.71	0.32	1.51	2500	3400	7.3
T 21.0	21.0 ± 0.5	13.0 ± 0.3	12.5 ± 0.5	5.34	0.50	2.67	3530	4670	12.9
T 25.0	25.0 ± 0.6	15.0 ± 0.5	10.0 ± 0.3	6.02	0.49	2.95	3070	3750	14.50
T 25.0	25.0 ± 0.6	15.0 ± 0.5	12.0 ± 0.4	6.28	0.60	3.77	3600	4800	18.3
T 27.5	27.5 ± 0.6	14.5 ± 0.5	6.5 ± 0.3	6.60	0.42	2.79	2414	3000	13.5
T 28.0	28.5 ± 0.4	13.5 ± 0.4	16.7 ± 0.4	6.59	1.25	8.76	7000	9000	40.1
T 31.5	31.5 ± 1.0	19.0 ± 0.6	12.5 ± 0.3	7.93	0.78	6.19	3825	4687	29
T 32.0	32.0 ± 0.7	14.5 ± 0.5	7.0 ± 0.3	7.30	0.61	4.47	3166	3940	22
T 36.0	36.0 ± 1.0	23.0 ± 0.6	15.0 ± 0.4	9.26	0.97	9.03	3950	5230	44
T 45	45.0 ± 1.4	28.0 ± 0.8	11.0 ± 0.4	11.50	0.94	10.81	3080	3850	52
T 50	50.0 ± 1.0	30.0 ± 0.8	20.0 ± 0.3	12.56	2.00	25.12	6000	8000	121.8
T 58.3	58.3 ± 1.0	40.8 ± 0.8	17.6 ± 0.4	15.56	1.54	23.96	3700	---	116.2
T 63.0	63.0 ± 1.3	38 ± 0.8	25.0 ± 0.5	15.85	3.125	49.53	11760	9500	240

Note : Epoxy coated Toroids in above types also can be made available.

Application of Small Rods
Crossover network
Filters

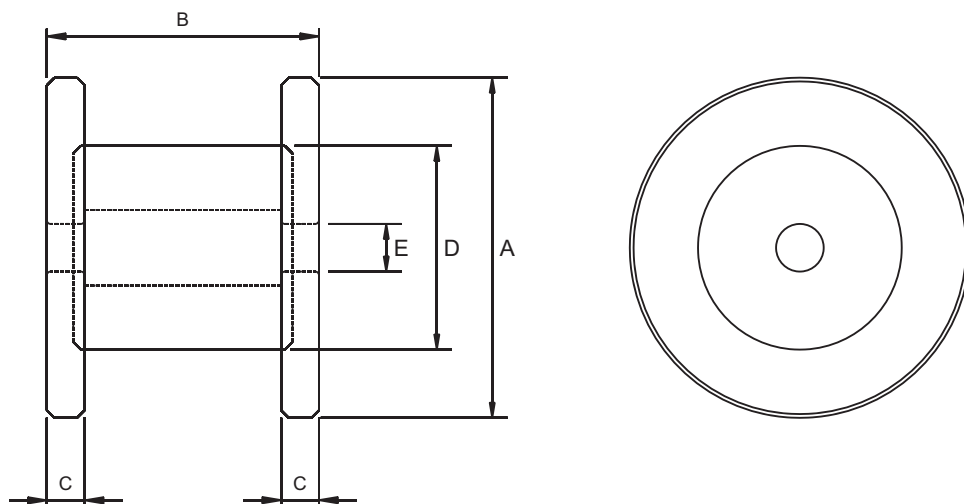

DIMENSIONS					
TYPE	A(mm)	B(mm)	C(mm)	D(mm)	E(mm)
OWD 22X15	22.00 ± 1.0	16.4 ± 1.5	3.20 ^{+0.6} _{-0.0}	12.00 ± 0.3	5.00 ^{+0.3} _{-0.0}
OWD 22X20	22.00 ± 1.0	21.4 ± 1.5	3.20 ^{+0.6} _{-0.0}	12.00 ± 0.3	5.00 ^{+0.3} _{-0.0}
OWD 28X20	28.00 ± 1.0	21.7 ± 1.5	3.85 ^{+0.6} _{-0.0}	16.90 ± 0.3	5.00 ^{+0.3} _{-0.0}
OWD 28X25	28.00 ± 1.0	26.70 ± 1.5	3.85 ^{+0.6} _{-0.0}	16.90 ± 0.3	5.00 ^{+0.3} _{-0.0}
OWD 35X25	35.00 ± 1.0	26.90 ± 1.5	4.45 ^{+0.6} _{-0.0}	21.00 ± 0.4	6.30 ^{+0.2} _{-0.0}
OWD 40X25	40.00 ± 1.0	26.00 ± 1.5	4.45 ^{+0.6} _{-0.0}	24.95 ± 0.5	6.30 ^{+0.2} _{-0.0}
OWD 40X35	45.00 ± 1.0	36.00 ± 1.5	5.00 ^{+0.6} _{-0.0}	26.95 ± 0.5	6.30 ^{+0.2} _{-0.0}
OWD 56X35	56.00 ± 2.5	35.00 ± 1.5	5.00 ^{+0.6} _{-0.0}	32.95 ± 0.5	6.30 ^{+0.2} _{-0.0}

Application of Small Rods

Application of Small Rods
 For Antennae
 For Choke and Filter
 For small Signal Transformers

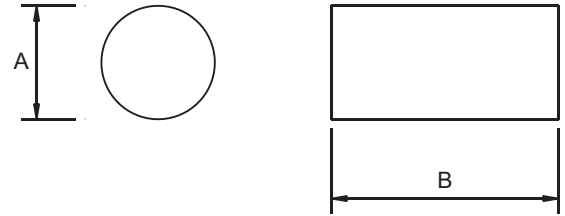

DIMENSIONS

Type	OD(mm)	Length(mm)
3x21.5	3.00 ± 0.30	21.50 ± 0.50
3.18X19.05	3.18 ± 0.30	19.05 ± 0.50
3.2X19	3.20 ± 0.30	19.00 ± 0.50
4.76X25	4.76 ± 0.30	25.00 ± 0.50
4.76X50	4.76 ± 0.30	50.00 ± 0.50
5x20	5.00 ± 0.30	20.00 ± 0.50
5x100	5.00 ± 0.30	100 ± 0.50
6x20	6.00 ± 0.30	20 ± 0.50
6.35X50.8	6.35 ± 0.20	50.80 ± 0.50
6.35X38.1	6.35 ± 0.20	38.10 ± 0.50
6.35X64.5	6.35 ± 0.20	64.50 ± 0.50
6.35X85	6.35 ± 0.20	85.00 ± 0.50
6.36X43.75	6.35 ± 0.20	43.75 ± 0.50
6.35X19.05	6.35 ± 0.20	19.05 ± 0.50
7.9X38.1	7.90 ± 0.30	38.10 ± 0.50
9.5X76.2	9.50 ± 0.30	76.20 ± 0.50
9.75X125	9.75 ± 0.30	125.00 ± 0.75
12.7X200	12.70 ± 0.40	200.00 ± 1.00
12.7X150	12.70 ± 0.40	150.00 ± 1.00
12.7X97	12.70 ± 0.40	97.00 ± 0.50
12.7X101.6	12.70 ± 0.40	101.60 ± 0.50
12.7X76.2	12.70 ± 0.40	76.20 ± 0.50
12.7X50.8	12.70 ± 0.40	50.80 ± 0.50
15.9X50.8	15.90 ± 0.40	50.80 ± 0.50
19.05x38.1	19.05 ± 0.40	38.10 ± 1.00

DIMENSIONS

Type	OD(mm)	ID(mm)	Length(mm)
4X2X20	4 ± 0.20	2.00 ± 0.20	20.00 ± 0.5
5X2.5X20	5 ± 0.30	2.50 ± 0.30	20.00 ± 0.5
6X3X20	6 ± 0.30	3.00 ± 0.20	20.00 ± 0.5
7X3X20	7 ± 0.30	3.00 ± 0.20	20.00 ± 0.5
8X3X20	8 ± 0.30	3.00 ± 0.20	20.00 ± 0.5
10X5X20	10 ± 0.40	5.00 ± 0.30	20.00 ± 0.5



Mahindra CIE

Mahindra CIE Automotive Limited

Magnetic Product Division (MPD)

Bhosari Industrial Estate, Pune - 411026, INDIA.

Telephone - 020 - 66120400 • Fax - 020 - 27128592

email: mpd.sales@mahindracie.com

Website - www.mahindracie.com