

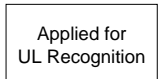

DIGITAL FIBER SENSOR

New **FX-301**



Innovation

SUNX concentrates its technological expertise to create **FX-301**. Superior performance and advanced user-friendly multi-functionality enables expert usage on the very first day.



'FX-301' - born from technological innovation. The ultimate fiber sensor has finally been born.

Fiber sensor have again taken one more step forward.

The deterioration of the light emitting elements over time, previously accepted as unavoidable, as well as the conventional idea that lenses could only be attached at the fiber end, have now finally been conquered with SUNX technology.

By utilizing a newly developed light emitting element composed of four chemical elements, which effectively eliminates deterioration, and by incorporating a lens within the fiber sensor itself, stable long-range sensing over long time periods - which has never before been possible - can now be easily implemented.

'FX-301' begins the first page in a new chapter of fiber sensors.

INNOVATION

Crystallizing the Evolution of SUNX Technology to Conquer Conventional Ideas

Specially Developed Light Emitting Element Extends Life Expectancy - No Need to Ever Adjust Incident Light Level

Newly developed

The quantity of light emitted from the light-emitting element in conventional fiber sensor tends to decrease due to the effects of temperature, as well as with element deterioration over time. In order to address this problem, APC (Auto Power Control) circuit is used to sense light reductions and compensate by increasing the amount of current to the light-emitting element, thereby stabilizing sensing operation. Although the incorporation of APC circuit is an effective means of correcting light levels, the element life expectancy is decreased due to the continual increases in electric current levels required for brightness compensation. On the contrary, our newly developed 'LED using four chemical elements' used in **FX-301**, has been specially formulated to reduce performance deterioration of the light-emitting element to the absolute minimum, thus producing stable incident light levels without the use of APC circuit. Furthermore, accurate and stable sensing operation can be maintained over very long periods, because reductions to element life expectancy from excessive electric current do not occur.

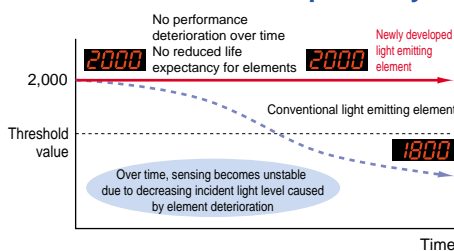

Long-range Sensing Made Possible with Built-in Optical Lens

Innovative feature

For the first time in the industry, an optical 'double coupling lens' has been incorporated directly into the fiber sensor itself. This lens maximizes the light emission efficiency, resulting in a tremendous improvement in the sensing range. Sensing ranges with small diameter fiber and ultra-small diameter fiber, which have become very popular in recent years due to the miniaturization of chip components, have been increased by 50% over previous values achieved with other amplifiers.

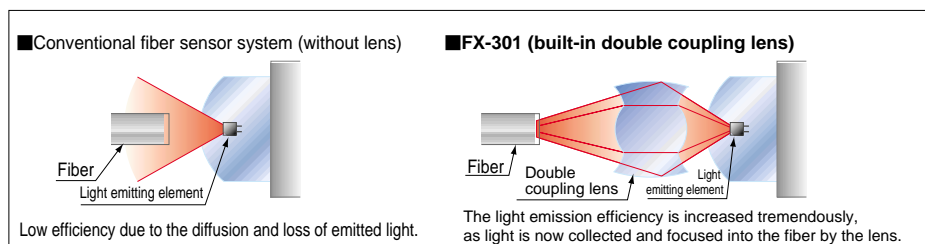

The Fastest Response Time has been Achieved

The fastest response time, 150 μs, is now available. Sensing range has also been greatly increased. As a result, high-speed detection utilizing ultra-small diameter fiber, previously unachievable due to problems with response time and range limitation, is now possible.

Response time

Switchable between three different levels

High-speed mode: 150 μs

Standard mode: 250 μs

Long-range mode: 2 ms

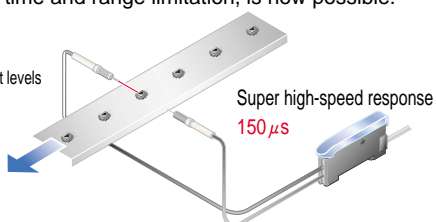

Now It's Possible to Simultaneously Cut Two Fibers to the Same Length

Newly developed

Our new fiber cutter utilizes a specially developed two-in-one fiber attachment that now makes it possible to cut two fibers simultaneously to exactly the same length. Also, since the fibers can be attached to the amplifier while being fixed in position in the two-in-one fiber attachment, sensitivity changes due to variation in the amount of fiber insertion do not occur.

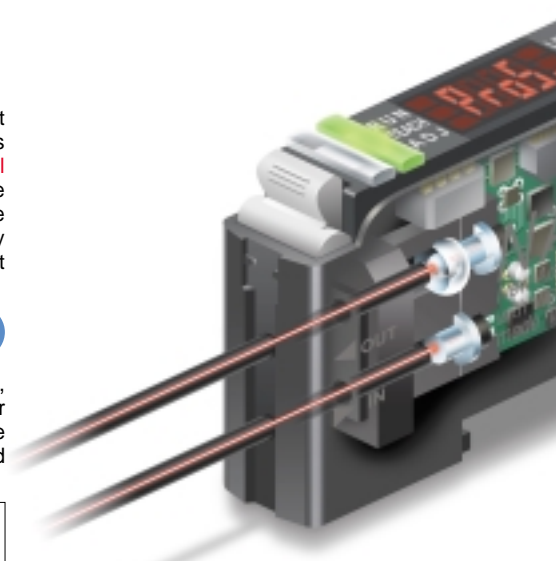
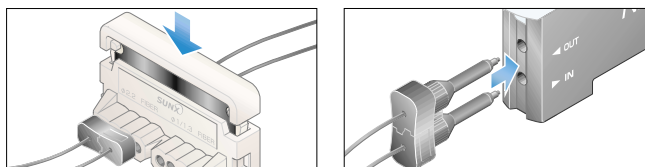

APPLICATION

The Flexible Design Addresses All User Concerns

Easy Maintenance, as Main and Sub Units Are Identical

Both main and sub units utilize the same amplifier body. This feature allows for easy mounting in the side-by-side configuration, because main and sub unit functions are distinguished only by the proper use of 3-core main cable for the main unit and 1-core sub cable for each sub unit. Moreover, due to the utilization of the same main body for both main and sub units, inventory management and maintenance, is simplified.

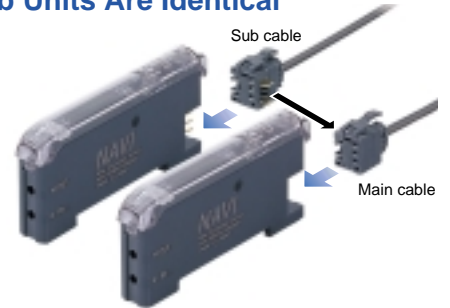

Wiring- and Labor-saving Design Allows Side-by-side Configuration for up to Sixteen Units

Up to sixteen amplifiers can be connected in a side-by-side configuration. As the sub cable contains only one output line, a great amount of wiring and space can be saved. Also, special 'sliding' connectors have been provided for all main and sub cables, which can be detached merely by releasing the lock and pulling directly back, without having to slide the main amplifier body to the side. Using this connector system, only a minimal amount of space is required for regular maintenance.

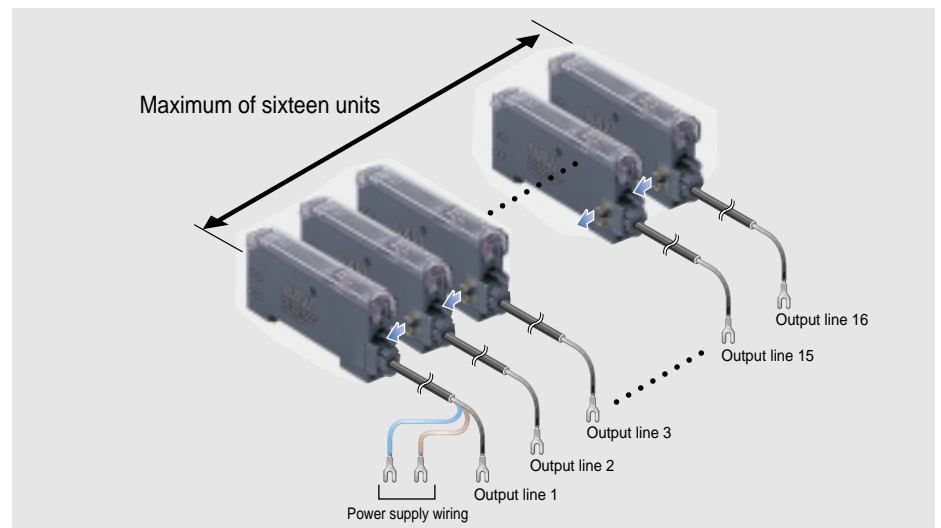
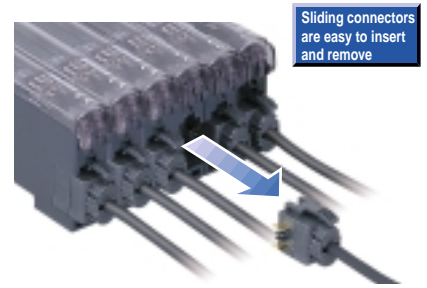

Optical Communications Function Enables Data Copying and Saving

By utilizing the optical communications feature, existing setting data can be copied from one amplifier and saved directly to all other amplifiers that are connected to its right hand side in the side-by-side configuration. Therefore, even cumbersome operations during set-up reconfiguration, etc., can be performed smoothly and efficiently.

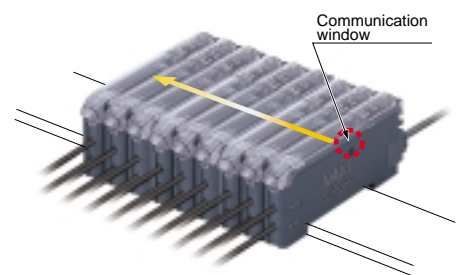

Close Mounting Is Possible for up to Four Fiber Heads

By employing the optical communications feature, mutual interference prevention is enabled for up to four closely mounted fiber heads. (Automatically set at time of power activation.)

Continuous pursuit of ease-of-use. You will be amazed by its impressive operability.

When considering fiber sensor design from the customer's viewpoint, we must consider the variety of useful features - and even more importantly - their ease-of-use.

'FX-301' integrates numerous technological innovations to make these ideals a reality.

Its amazing usability is made possible by the utilization of MODE NAVI and two large switches.

MODE NAVI contains an easy-to-understand display system and is very simple to operate.

Just two large switches are used to control all MODE NAVI functions.

You will be an expert from the moment you pick up an FX-301!

INSTRUCTION

Easy to Understand, Even for Beginners
Simple and Confusion-free Operation

RUN		RUN→ This is the sensing mode. Incident light level is displayed in the digital display.
TEACH		TEACH→ This mode is for setting the threshold value.
ADJ		ADJ→ In this mode, the threshold value, once set, may be fine-tuned.

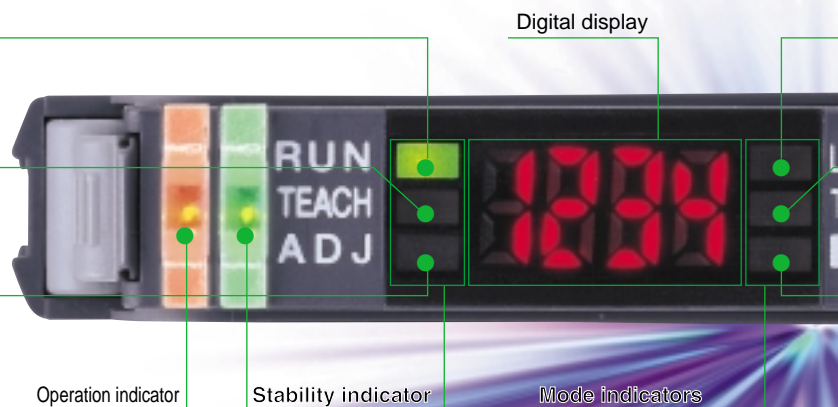

Easy Operation with MODE NAVI

MODE NAVI uses six indicators to display the amplifier's basic operations. The current operating mode can be confirmed at a glance, so even a first time user can easily operate the amplifier without becoming confused.

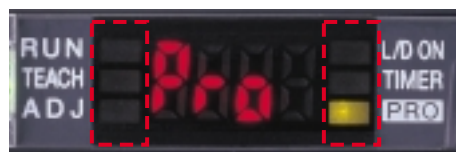

MODE NAVI (MODE indicators)

Blinking Indicator Displays the Margin in Sensitivity

When setting the threshold value, the margin in sensitivity can be confirmed by the number of times the stability indicator blinks.

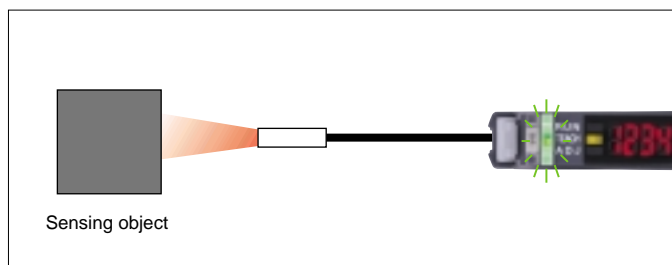

* Blinking five times indicates the highest level of sensitivity.

MODE

OPERATION

Very easy operation, even with multiple functions. Provides amazing usability.

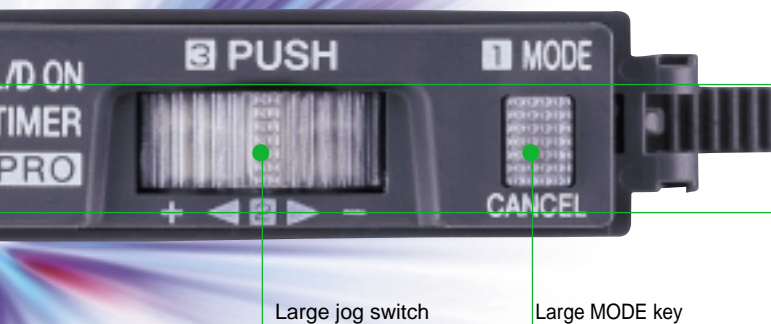

Large jog switch

Large MODE key

L/D ON	L/D ON →	This mode allows the selection of output operation as either Light-ON or Dark-ON.
TIMER	TIMER →	This mode permits the choice of using or not using the timer. (Timer settings are made using PRO1.)
PRO	PRO →	This mode allows the selection of further advanced functions, such as the copying of individual settings and the memory functions.

Simple Operation with Easy Access to Advanced Functions

Each mode can be selected using the large MODE key. Detailed functions and settings can be chosen using the large jog switch. Each setting mode can be easily confirmed by viewing the MODE indicator display. The advanced features available in each mode can be easily viewed and smoothly selected from the digital display. Further, by utilizing the various functions incorporated in the five 'PRO modes', even more sensitive detection and fine settings may be performed.

※ Please refer to P.5~ for more details of the PRO modes.

Two Switches with Distinct Functions

Only two switches, the large jog switch and the large MODE key, are required for operation. Depressing the large MODE key sets the 'mode selection' and 'mode cancel' functions. The large jog switch is used to select from the detailed functions available within each mode, as well as to change numerical values after the mode has been chosen. The use of only two switches makes for very simple operations and easy maintenance.

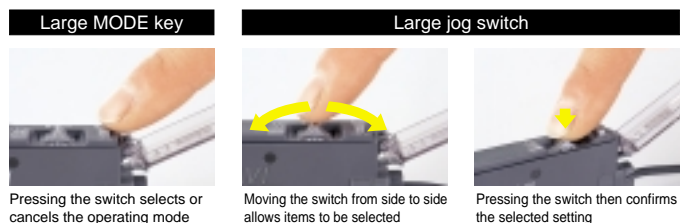

Pressing the switch selects or cancels the operating mode

Moving the switch from side to side allows items to be selected

Pressing the switch then confirms the selected setting

New Advanced sensor with Visible Indicator

NAVI

Advanced fiber sensor with high performance detection features, navigated using superior display technology.

IMAGINATION

Multifeatured PRO Mode, Supports Efficient Operation

What PRO mode is...

PRO1 - PRO5 incorporate various functions, such as settings required for fine detection operations inaccessible through basic operation settings, as well as features that further improve usability.

PRO mode
application example

High-speed sensing of extremely minute chip components during drop sorting

For example, by utilizing the PRO mode, extremely small objects passing the sensor at very high speeds, can now be reliably detected where detection had previously been difficult.

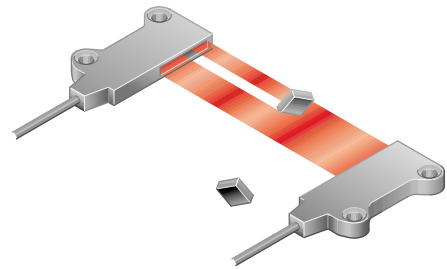

Hysteresis function/**H45**
PRO1

Hysteresis is set to H-01, a small hysteresis value, for sensing of extremely minute objects.

Three different levels are available

- H-01 (small)
- H-02 (standard)
- H-03 (large)

Response time change function/**SPEd**
PRO1

High-speed mode, having a response time of $150\ \mu\text{s}$, is selected.

Three different levels are available

- FAST $<150\ \mu\text{s}$ (high-speed mode) $>$
- STD $<250\ \mu\text{s}$ (standard mode) $>$
- LONG $<2\text{ms}$ (long-range mode) $>$

Timer setting function/**dELY**
PRO1

Signal pulse width is set to 1ms with the ONE-SHOT timer.

As the PLC cannot recognize a signal with a pulse width of only about $150\ \mu\text{s}$, the ONE-SHOT timer is selected, with a setting of 1ms, thus ensuring adequate pulse width for correct signal detection by the PLC.

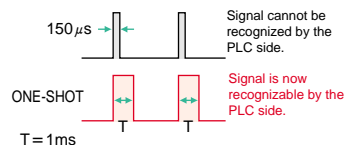

Digital display setting function/**d15P**
PRO2

Bottom hold is utilized.

During sensing operation (RUN), the following data can be selected for viewing on the digital display: incident light level (numerical value), peak value (peak hold), bottom value (bottom hold) and percentage. Selecting 'bottom hold' displays the minimum incident light level when light is blocked from the sensor by the high-speed passage of an extremely small object. This feature allows confirmation of the difference between incident light levels at times when the light is not blocked and when the light is being blocked. The bottom hold value is a guideline for determining threshold value at the time of installation.

Individual Configuration and Setting Data can be Displayed and Saved!

Data Bank Load & Save Setting Function/**chLD** & **chSR** **PRO3**

Configuration and setting data, which has been previously saved in the data bank, can be displayed and used to replace the current configuration settings. Also, current configuration settings can be saved in the selected data bank. The data bank contains channels 1 - 3, reducing setting time required during reconfiguration.

With the Optical Communications Feature, Only One Single Step Is Required to Perform Data Copy, Read-out and Save Functions for All Amplifiers Connected in Side-by-side Configuration!

The optical communications feature

FX-301 incorporates an optical communications feature. When several amplifiers are connected in the side-by-side configuration, this function allows the setting status to be altered for units connected on the right side of the operating amplifier.

Setting Condition Copy Function/**copy** **PRO4**

The configuration data for an operating amplifier can be copied to all other amplifiers that are connected to it on the right side. (Except for data bank contents.)

Remote Data Bank Load & Save Setting Function/**chLD** & **chSR** **PRO4**

When a group of amplifiers are connected in the side-by-side configuration, this function allows all setting data, previously saved in the data banks, of the amplifiers on the right hand side of the operating amplifier to be read out simultaneously and become the new configuration setting. Further, the current setting can also be simultaneously stored in the data bank of each amplifier.

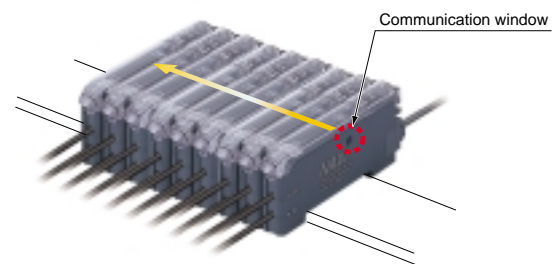

Direct Setting Is Made Possible Through Numerical Inputs!

Code Setting Function/

PRO5

Every function can be directly set merely by the input of a four digit code (numbers) from the code table. This convenient feature is easy to set up.

Also, when setting is done by any means other than direct code input, the existing code will be automatically changed (However, if the selected settings is not contained within the code table, then the code will be displayed as '----').

In the event that settings are accidentally changed at the operating site, merely entering the correct code can restore the original settings. This results in easy and quick maintenance.

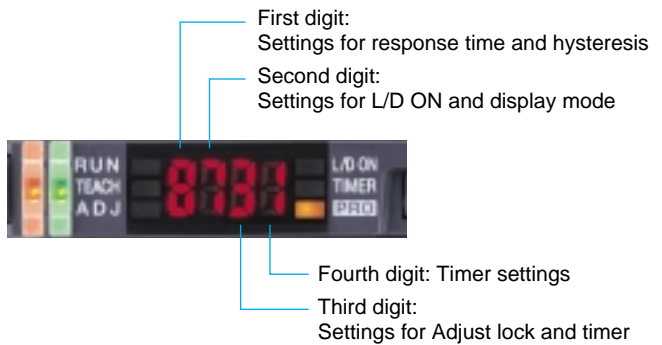

[Code setting table]

Direct code	First digit		Second digit		Third digit		Fourth digit
	Response time	Hysteresis	L/D ON	Display mode	Adjust lock	Timer	Timer setting
0	STD	H-02 (standard)	L-ON	digit	ON	OFF	OFF
1	STD	H-03 (large)	L-ON	%	ON	OFF-delay	1ms
2	STD	H-01 (small)	L-ON	Peak hold	ON	ON-delay	3ms
3	LONG	H-02 (standard)	L-ON	Bottom hold	ON	ONE-SHOT	5ms
4	LONG	H-03 (large)	D-ON	digit	OFF	OFF	10ms
5	LONG	H-01 (small)	D-ON	%	OFF	OFF-delay	30ms
6	FAST	H-02 (standard)	D-ON	Peak hold	OFF	ON-delay	50ms
7	FAST	H-03 (large)	D-ON	Bottom hold	OFF	ONE-SHOT	100ms
8	FAST	H-01 (small)	/	/	/	/	300ms
9	/	/	/	/	/	/	500ms

[Setting example]

In case 'high-speed sensing for extremely minute chip components during drop sorting', described on P. 5, is set by entering a direct code. (Code 8731)

	Code
Response time : FAST (150μs) Hysteresis : H-01(small)	8
Operating mode : D-ON Display mode : Bottom hold	7
Adjust lock : ON Timer : ONE-SHOT	3
Timer setting : 1ms	1

Incident Light Level and Sensitivity can be Adjusted!

0-ADJ Setting Function/

PRO5

The digital display allows for automatic zeroing of the incident light level. When incident light is always at the same level, the difference in incident light levels between normal status and sensing status can be verified. This function is also useful for eliminating any differences between the displayed incident light level values for each connected amplifier.

Adjust Lock Setting Function/

PRO5

If adjust lock is set to OFF, then fine-tuning for sensitivity can be performed by using the jog switch, even during sensing operation (RUN). This feature is very convenient when delicate adjustments are required. When adjust lock is set to OFF, besides the RUN indicator (green), which displays sensing status, the ADJ indicator (yellow) will also light up. The initial status of adjust lock is ON.

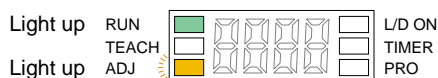

Digital Display Orientation can be Changed!

Digital Display Inversion Function/

PRO2

The orientation of the digital display can be flipped and reversed. The initial status for display orientation is 'turn OFF'.

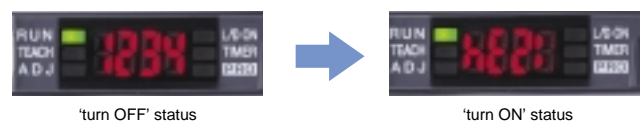

Power Saving Feature Available!

ECO Mode Setting Function/

PRO2

When ECO mode is selected, the digital display will turn off in order to reduce power consumption. The initial status for ECO mode is 'ECO OFF'.

New fiber range

New fiber range for variety of applications

Ultra-small diameter fiber

Thru-beam type
FT-E12, FT-E22
Reflective type
FD-E12, FD-E22

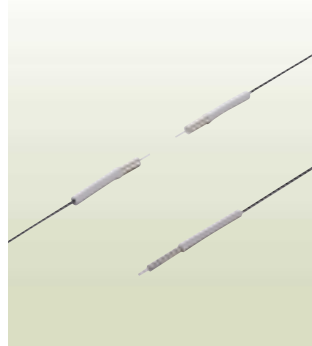

No. 1 in the industry
Sleeve head diameter of only $\phi 0.25\text{mm}$ has been realized!

- Thru-beam types, **FT-E12** and **FT-E22**
Improved sensing performance for extremely minute objects. By shortening sleeve length to 10mm, a more compact installation is possible.
- Reflective types, **FD-E12** and **FD-E22**
Product line with $\phi 3\text{mm}$ sleeve.

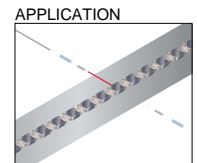

Verifying the passage of a chip

Reflective type flexible fiber

$\phi 3\text{mm}$ non-threaded type
FD-P50
M4 threaded type
FD-P60



Sensing range has been remarkably increased!
Repeatability has been improved!

- The quantity of light has been doubled by increasing the number of fiber stands from the previous 4 stands $\times 2$ to 7 stands $\times 2$. Owing to this improvement, a sensing distance of 70mm has been realized.
- Minimum allowable bending radius is R4mm.
- The flexibility has been improved remarkably; the fiber can withstand repeated bending of one million cycles or more (at R10mm).

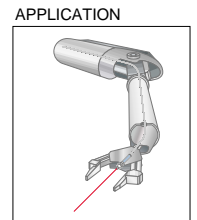

Sensing objects with a robotic hand

Flexible heat-resistant fiber

FT-H20W SERIES

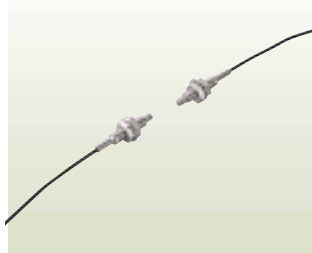

A bending radius of R10mm is possible even in high temperature environments!

- Withstands temperature up to 200°C
Sensing is now possible in high temperature environments, such as detecting the presence of ICs in a high temperature handler.
- By utilizing a PTFE exterior coating, bends of R10mm are possible, even in high temperature environments. Cabling can be laid out freely, thus saving space.
- Fibers are available in lengths of 1m and 2m.

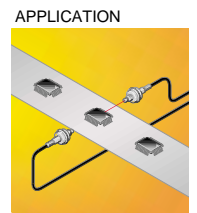

Detecting the presence of ICs in a high temperature handler

Rectangular head fiber

FT-Z8 SERIES

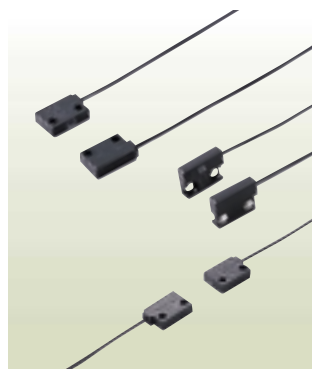

Smallest in the industry!
Easy, space-saving screw type installation

- The smallest, super thin type, rectangular head fiber head in the industry with dimensions of $W3 \times H12 \times D8\text{mm}$ (side sensing type).
- It can be installed with only two M2 screws, allowing easy light beam axis alignment.
- Minimum permissible bending radius of R4mm.
- The fiber can withstand repeated bending of one million cycles or more (at R10mm).

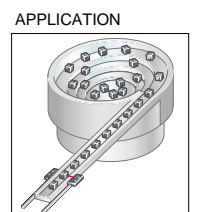

Detecting components from a parts feeder

LIST OF FIBERS

Thru-beam type (one pair set)



Type	Shape of fiber head (mm)	Sensing range (Note 1)	Min. sensing object (under the optimum condition (Note 2))	Features	Fiber cable length	Allowable bending radius	Model No.
Standard	Lens mountable 	<div style="display: flex; align-items: center;"> <div style="width: 15px; height: 15px; border: 1px solid black; background-color: #e0e0e0; margin-right: 5px;"></div> : LONG <div style="width: 15px; height: 15px; border: 1px solid black; background-color: #a0a0a0; margin-right: 5px;"></div> : STD <div style="width: 15px; height: 15px; border: 1px solid black; background-color: #404040; margin-right: 5px;"></div> : FAST </div> 	φ 0.04mm opaque object	· 1.5 times the sensing range as standard type	Free Cut 2m	R25mm or more	FT-B8
Small diameter			φ 0.025mm opaque object	· Suitable for detection in a congested equipment	Free Cut 2m	R25mm or more	FT-NFM2
Ultra-small diameter	Sleeve part cannot be bend. 		φ 0.02mm opaque object	· Ultra-small diameter heads, very narrow beam φ 0.125mm	500mm	R5mm or more (except for sleeve part)	New FT-E12
Ultra-small diameter	Sleeve part cannot be bend. 		φ 0.02mm opaque object	· Ultra-small diameter heads, very narrow beam φ 0.25mm	1m	R5mm or more (except for sleeve part)	New FT-E22

Notes: 1) Please take care that the sensing range of the free-cut type fiber may be reduced by 20% max. depending upon how the fiber is cut.

2) The optimum condition is the condition when the threshold value is set so that the sensing output just changes to light incident operation in the object absent condition.

Reflective type



Type	Shape of fiber head (mm)	Sensing range (Note 1)(Note 2)	Min. sensing object (at the Max. sensitivity (Note 3))	Features	Fiber cable length	Allowable bending radius	Model No.
Standard		<div style="display: flex; align-items: center;"> <div style="width: 15px; height: 15px; border: 1px solid black; background-color: #e0e0e0; margin-right: 5px;"></div> : LONG <div style="width: 15px; height: 15px; border: 1px solid black; background-color: #a0a0a0; margin-right: 5px;"></div> : STD <div style="width: 15px; height: 15px; border: 1px solid black; background-color: #404040; margin-right: 5px;"></div> : FAST </div> 	φ 0.02mm gold wire	· Long sensing range	Free Cut 2m	R25mm or more	FD-B8
Small diameter			φ 0.02mm gold wire	· Suitable for detection in a congested equipment	Free Cut 2m	R25mm or more	FD-NFM2
Ultra-small diameter	Sleeve part cannot be bend. 		φ 0.02mm gold wire	· Easy fine adjustments for precise positioning during installation	1m	R10mm or more (except for sleeve part)	New FD-E12
Ultra-small diameter	Coaxial Sleeve part cannot be bend. 		φ 0.02mm gold wire	· Precise position sensing with coaxial fiber	1m	R25mm or more (except for sleeve part)	New FD-E22

Notes: 1) The sensing range is specified for white non-glossy paper (FD-B8/FM2: 400 × 400mm, FD-NFM2: 200 × 200mm, FD-E12/E22: 100 × 100mm).

2) Please take care that the sensing range of the free-cut type fiber may be reduced by 20% max. depending upon how the fiber is cut.

3) The minimum sensing object is specified for maximum sensitivity. Also, note that the corresponding setting distance is different from the rated sensing distance.

FX-301

ORDER GUIDE

Amplifiers

Appearance	Model No.	Emitting element	Output
	FX-301	Red LED	NPN open-collector transistor
	FX-301P		PNP open-collector transistor

Quick-connection cables

Type	Model No.	Description	
Main cable	CN-73-C1	Length: 1m	0.2mm ² 3-core cabtyre cable, with connector on one end Cable outer diameter: ϕ 3.8mm
	CN-73-C2	Length: 2m	0.2mm ² 3-core cabtyre cable, with connector on one end Cable outer diameter: ϕ 3.8mm
	CN-73-C5 (sales starting soon)	Length: 5m	0.2mm ² 3-core cabtyre cable, with connector on one end Cable outer diameter: ϕ 3.8mm
Sub cable	CN-71-C1	Length: 1m	0.2mm ² 1-core cabtyre cable, with connector on one end Cable outer diameter: ϕ 3.8mm
	CN-71-C2	Length: 2m	0.2mm ² 1-core cabtyre cable, with connector on one end Cable outer diameter: ϕ 3.8mm
	CN-71-C5 (sales starting soon)	Length: 5m	0.2mm ² 1-core cabtyre cable, with connector on one end Cable outer diameter: ϕ 3.8mm

Quick-connection cable is not supplied with the amplifier. Please order it separately.

OPTIONS

Designation	Model No.	Description
Amplifier mounting bracket	MS-DIN-2	Mounting bracket for amplifier
End plates	MS-DIN-E	When connecting multiple amplifiers, these end plates ensure that all amplifiers are mounted together in a secure and fully connected manner. Two Nos. per set

Amplifier mounting bracket

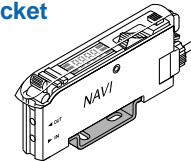

End plates

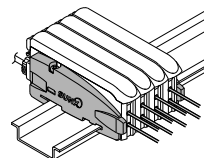

SPECIFICATIONS

Refer to Fiber Sensor Guide Book or Sensor General Catalog for fiber's specifications.

	Type	NPN output	PNP output
Item	Model No.	FX-301	FX-301P
Supply voltage		12 to 24V DC \pm 10% Ripple P-P 10% or less	
Power consumption		Normal operation: 960mW or less (Current consumption 40mA or less at 24V supply voltage) ECO mode: 600mW or less (Current consumption 25mA or less at 24V supply voltage)	
Output		NPN open-collector transistor <ul style="list-style-type: none"> • Maximum sink current: 100mA (Note 1) • Applied voltage: 30V DC or less (between output and 0V) • Residual voltage: 1.5V or less [at 100mA (Note 1) sink current] 	PNP open-collector transistor <ul style="list-style-type: none"> • Maximum source current: 100mA (Note 1) • Applied voltage: 30V DC or less (between output and + V) • Residual voltage: 1.5V or less [at 100mA (Note 1) source current]
	Utilization category	DC-12 or DC-13	
	Output operation	Selectable either Light-ON or Dark-ON, with jog switch	
	Short-circuit protection	Incorporated	
Response time		150 μ s or less (FAST), 250 μ s or less (STD), 2ms or less (LONG) selectable with jog switch	
Sensitivity setting		2-level teaching / Limit teaching / Manual adjustment	
Operation indicator		Orange LED (lights up when the output is ON)	
Stability indicator		Green LED (lights up under stable light received condition or stable dark condition)	
MODE indicator		RUN: Green LED, TEACH • ADJ • L/D ON • TIMER • PRO: Yellow LED	
Digital display		4 digit 7 segment red LED display	
Fine sensitivity adjustment function		Incorporated	
Timer function		Incorporated with variable ON-delay / OFF-delay / ONE-SHOT timer, switchable either effective or ineffective (timer: 0.5 to 500ms approx.)	
Automatic interference prevention function		Incorporated (for up to four amplifier connected in cascade) (Note 2)	
Environmental resistance	Pollution degree	3 (Industrial environment)	
	Ambient temperature	- 10 to + 55°C (If 4 to 7 units are connected in cascade: - 10 to + 50°C, if 8 to 16 units are connected in cascade: - 10 to + 45°C) (No dew condensation or icing allowed), Storage: - 20 to + 70°C	
	Ambient humidity	35 to 85% RH, Storage: 35 to 85% RH	
	Ambient illuminance	Sunlight: 10,000 lx at the light-receiving face, Incandescent light: 3,000 lx at the light-receiving face	
	EMC	Emission: EN50081-2, Immunity: EN50082-2	
	Voltage withstandability	1,000V AC for one min. between all supply terminals connected together and enclosure (Note 3)	
	Insulation resistance	20M Ω , or more, with 250V DC megger between all supply terminals connected together and enclosure (Note 3)	
	Vibration resistance	10 to 150Hz frequency, 0.75mm amplitude in X, Y and Z directions for two hours each	
Shock resistance	98m/s ² acceleration (10G approx.) in X, Y and Z directions for five times each		
Emitting element		Red LED (modulated)	
Material		Enclosure: Heat-resistant ABS, Case cover: Polycarbonate, Switch: Acrylic	
Connecting method		Connector connection	
Cable extension		Extension up to total 100m is possible with 0.3mm ² , or more, cable	
Weight		25g approx.	

Notes: 1) 50mA, if five, or more, amplifiers are connected in cascade.

2) When the power supply is switched on, the emission timing are automatically set for interference prevention.

3) The voltage withstandability and the insulation resistance values given in the above table are for the amplifier only.

4) The cable for amplifier connection is not supplied as an accessory. Make sure to use the optional quick-connection cable given below.

Main cable (3-core): **CN-73-C1** (cable length 1m), **CN-73-C2** (cable length 2m), **CN-73-C5** (cable length 5m, sales starting soon)

Sub cable (1-core): **CN-71-C1** (cable length 1m), **CN-71-C2** (cable length 2m), **CN-71-C5** (cable length 5m, sales starting soon)

I/O CIRCUIT AND WIRING DIAGRAMS

FX-301 NPN output

I/O circuit diagram

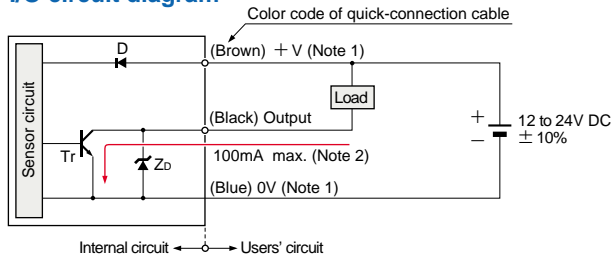

Notes: 1) The quick-connection sub cable does not have +V (brown) and 0V (blue).
2) 50mA max., if five amplifiers, or more, are connected together.

Symbols ... D : Reverse supply polarity protection diode
Z_D: Surge absorption zener diode
Tr : NPN output transistor

Wiring diagram

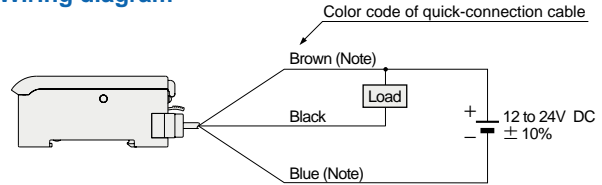

Note: The quick-connection sub cable does not have brown cable and blue cable.

Terminal arrangement diagram

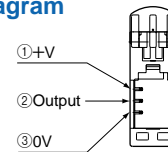

FX-301P PNP output

I/O circuit diagram

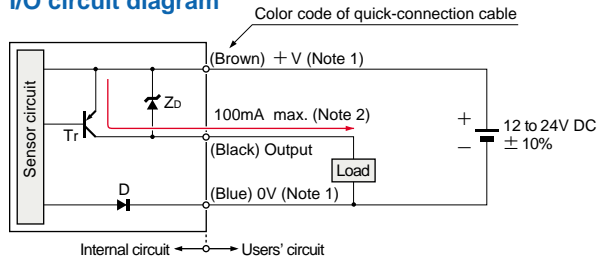

Notes: 1) The quick-connection sub cable does not have +V (brown) and 0V (blue).
2) 50mA max., if five amplifiers, or more, are connected together.

Symbols ... D : Reverse supply polarity protection diode
Z_D: Surge absorption zener diode
Tr : PNP output transistor

Wiring diagram

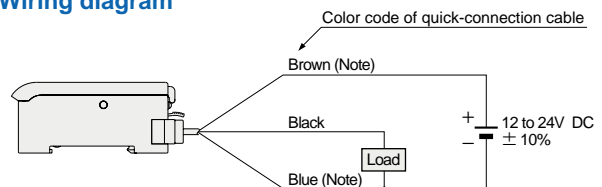

Note: The quick-connection sub cable does not have brown cable and blue cable.

Terminal arrangement diagram

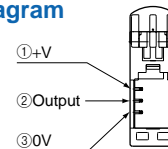

PRECAUTIONS FOR PROPER USE

Refer to Sensor General Catalog for fiber's precautions



This product is not a safety sensor. Its use is not intended or designed to protect life and prevent body injury or property damage from dangerous parts of machinery. It is a normal object detection sensor.

Part description

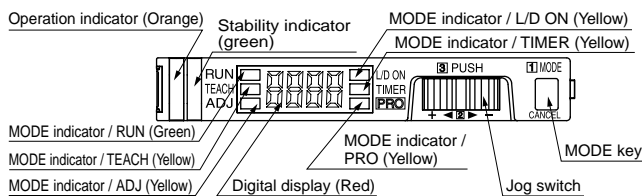

Operation procedure

- When the power supply is switched on, communication self-check is carried out and normal condition is displayed [MODE indicator / RUN (green) lights up and the digital display shows incident light intensity].
- When MODE key is pressed, the mode changes as per the diagram below.

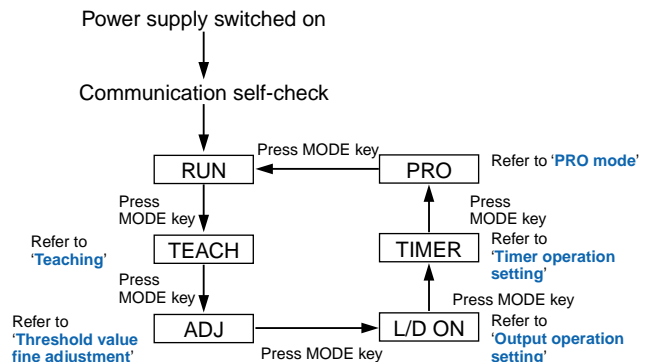

When jog switch is pressed, the setting is confirmed.
When MODE key is pressed for 2 sec., or more, the sensor returns to the RUN mode.
Cancellation is possible by pressing MODE key during setting.

PRECAUTIONS FOR PROPER USE

Refer to Sensor General Catalog for fiber's precautions

Teaching

- The threshold values can be set by either 2-level teaching or limit teaching, when the MODE indicator / TEACH (yellow) lights up.

In case of 2-level teaching

- This is the method of setting the threshold value by teaching two levels, corresponding to the object present and object absent conditions. Normally, setting is done by this method.

Step	Description	Display
①	Set the fiber within the sensing range. Press MODE key to light up MODE indicator / TEACH (yellow).	
②	Press jog switch in the object present condition. If the teaching is accepted, the read incident light intensity blinks in the digital display. Thru-beam type Reflective type 	
③	MODE indicator / TEACH (yellow) blinks. Press jog switch in the object absent condition. Thru-beam type Reflective type 	
④	If the teaching is accepted, the read incident light intensity blinks in the digital display and the threshold value is set at the mid-value between the incident light intensities in the object present and the object absent conditions. After this, the judgement on the stability of sensing is displayed. • In case stable sensing is possible: 'Good' is displayed. Stability indicator (green) blinks. • In case stable sensing is not possible: 'NR.d' is displayed. Stability indicator (green) is off.	
⑤	The threshold value is displayed.	
⑥	'....' blinks in the digital display.	
⑦	The incident light intensity appears in the digital display and the setting is complete.	

Note: Do not move or bend the fiber cable after the sensitivity setting. Detection may become unstable.

In case of limit teaching

- This is the method of setting the threshold value by teaching only the object absent condition (stable incident light condition). This is used for detection in the presence of a background body or for detection of small objects.





Step	Description	Display
①	Set the fiber within the sensing range. Press MODE key to light up MODE indicator / TEACH (yellow). 	
②	Press jog switch in the object absent condition. If the teaching is accepted, the read incident light intensity blinks in the display. Thru-beam type Reflective type 	
③	MODE indicator / TEACH (yellow) blinks. Turn jog switch to the '+' side or '-' side.	
④	If jog switch is turned to the '+' side, '...' scrolls (twice) the display from right to left, and the threshold level is shifted to a value approx. 15% higher (lower sensitivity) than that set at ②. (Note 1) This is used in case of reflective type fibers. If jog switch is turned to the '-' side, '...' scrolls (twice) the display from left to right, and the threshold level is shifted to a value approx. 15% lower (higher sensitivity) than that set at ②. (Note 1) This is used in case of thru-beam type fibers. 	
⑤	After this, the judgement on whether the setting shift amount can be shifted or not is displayed. • In case shifting is possible: 'Good' is displayed. • In case shifting is not possible: 'NR.d' is displayed.	
⑥	The threshold value is displayed.	
⑦	'....' blinks in the digital display.	
⑧	The incident light intensity appears in the digital display and the setting is complete.	

- Notes: 1) The approx. 15% amount of shift is the initial value. The amount of shift can be changed in the PRO mode from approx. 5 to 50% (5% step). Refer to Fiber Sensor Guide Book for details of the setting method.
2) Do not move or bend the fiber cable after the sensitivity setting. Detection may become unstable.



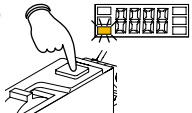
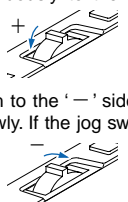

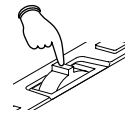

PRECAUTIONS FOR PROPER USE

Refer to Sensor General Catalog for fiber's precautions

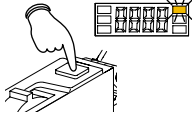
Threshold value fine adjustment

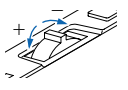
Step	Description	Display
①	Press MODE key to light up MODE indicator / ADJ (yellow). 	---
②	In case the threshold value is to be increased (sensitivity to be reduced), turn the jog switch to the '+' side to increase the threshold value slowly. If the jog switch is turned continuously to the '+' side, the threshold value increases rapidly. In case the threshold value is to be decreased (sensitivity to be increased), turn the jog switch to the '-' side to decrease the threshold value slowly. If the jog switch is turned continuously to the '-' side, the threshold value decreases rapidly. 	 ↓  or  ↓ 
③	When jog switch is pressed, the threshold value is confirmed. 	---

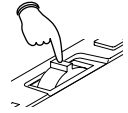
Output operation setting

Step	Description	Display
①	Press MODE key to light up MODE indicator / L/D ON (yellow). 	 Displays present setting
②	If the jog switch is turn to the '+' or '-' direction, the output operation setting will change. 	 ↓ Light state ↑  Dark state
③	When jog switch is pressed, output operation is confirmed. 	 Displays selected setting

Timer operation setting

- The setting for whether the timer is used or not can be done when MODE indicator / TIMER (yellow) lights up.
- 10ms OFF-delay (initial value) timer is automatically set when the timer is set to be used.
- Further, an OFF-delay (initial value) which is useful when the response of the connected device is slow, etc., an ON-delay which is useful to detect only objects taking a long time to travel, and ONE-SHOT, which is useful when the input specifications of the connected device require a signal of a fixed width, are possible with **FX-301**.
Refer to Fiber Sensor Guide Book for the setting method of the OFF-delay, ON-delay and ONE-SHOT timer intervals.

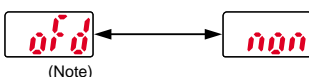





Note: The OFF-delay timer interval set in the PRO mode is displayed. Please refer to Fiber Sensor Guide Book for more details.

PRO mode

- For details of the settings and the setting procedure of the PRO mode, refer to Fiber Sensor Guide Book.
- The above can also be download from SUNX fiber sensor homepage (<http://www.fiber-sensor.com>)
- PRO settings can be done when MODE indicator / PRO (yellow) lights up.

Table for PRO mode settings

	Display	Description
PRO1		① Response time change function 'SPED' ② Timer setting function 'dELY' ③ Hysteresis function 'HYS' ④ Stability function 'StB' ⑤ Limit teaching function 'SWT'
PRO2		① Digital display setting function 'dISP' ② Digital display inversion function 'turn' ③ ECO mode setting function 'Eco'
PRO3		① Data bank load setting function 'chLD' ② Data bank save setting function 'chSR'
PRO4		① Setting condition copy function 'COPY' ② Remote data bank load setting function 'chLD' ③ Remote data bank save setting function 'chSR' ④ Communication condition confirmation function 'EESC'
PRO5		① Code setting function 'Code' ② 0-ADJ setting function 'BRd' ③ Adjust lock setting function 'R.Lc' ④ Setting reset function 'rSet'

Wiring

- Make sure to carry out the wiring in the power supply off condition.
- Verify that the supply voltage variation is within the rating.
- Take care that if a voltage exceeding the rated range is applied, or if an AC power supply is directly connected, the sensor may get burnt or damaged.
- If power is supplied from a commercial switching regulator, ensure that the frame ground (F.G.) terminal of the power supply is connected to an actual ground.
- In case noise generating equipment (switching regulator, inverter motor, etc.) is used in the vicinity of this product, connect the frame ground (F.G.) terminal of the equipment to an actual ground.
- Take care that short-circuit or wrong wiring of the load may burn or damage the sensor.
- Do not run the wires together with high-voltage lines or power lines or put them in the same raceway. This can cause malfunction due to induction.
- Ensure that an isolation transformer is utilized for the DC power supply. If an autotransformer is utilized, the main amplifier or power supply may be damaged.
- Make sure to use the optional quick-connection cable for the connection of the amplifier. Extension up to total 100m is possible with 0.3mm², or more, cable. However, in order to reduce noise, make the wiring as short as possible.

Others

- Do not use during the initial transient time (0.5 sec. approx.) after the power supply is switched on.
- Take care that the sensor is not directly exposed to fluorescent light from a rapid-starter lamp or a high frequency lighting device, as it may affect the sensing performance.
- This sensor is suitable for indoor use only.
- Avoid dust, dirt, and steam.
- Take care that the product does not come in direct contact with organic solvents, such as, thinner, etc.
- This sensor cannot be used in an environment containing inflammable or explosive gases.
- Never disassemble or modify the sensor.

DIMENSIONS (Unit: mm)

Refer to Fiber Sensor Guide Book or Sensor General Catalog for fiber's dimensions

FX-301 Amplifier

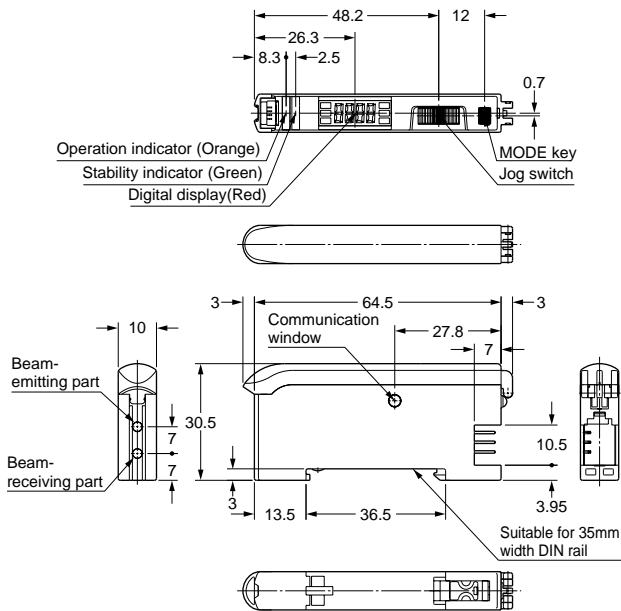

CN-73-C1 CN-73-C5 CN-73-C2 Main cable (Optional)

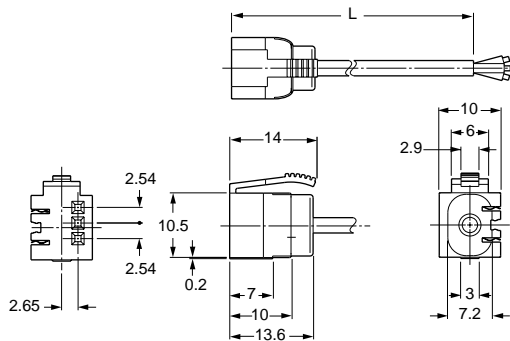

▪ Length

Model No.	Length (mm)
CN-73-C1	1,000
CN-73-C2	2,000
CN-73-C5	5,000

CN-71-C1 CN-71-C5 CN-71-C2 Sub cable (Optional)

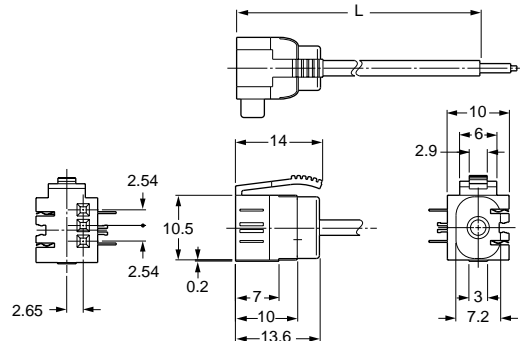

▪ Length

Model No.	Length (mm)
CN-71-C1	1,000
CN-71-C2	2,000
CN-71-C5	5,000

MS-DIN-2 Amplifier mounting bracket (Optional)

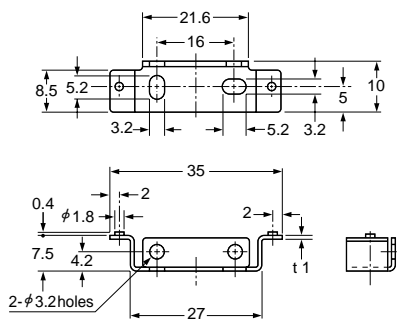

Material: Cold rolled carbon steel (SPCC)
(Uni-chrome plated)

MS-DIN-E End plates (Optional)

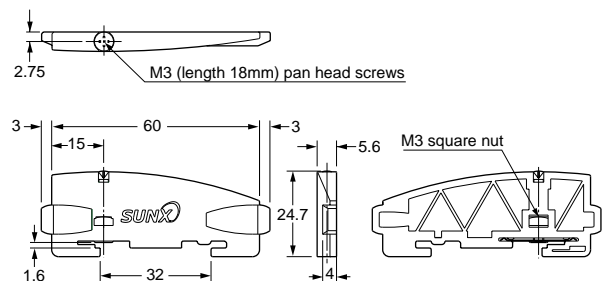

Fiber Sensor Guide Book is available

We have published a 'Fiber Sensor Guide Book' containing information about fibers not described in this catalog, as well as detailed information about the PRO mode. This guide book contains a selection guide, to assist you in easily choosing the right fibers to meet your special sensing requirements. Please request the guide book from your sales representative.



All information is subject to change without prior notice.



<http://www.sunx.co.jp/>

SUNX Limited

2431-1 Ushiyama-cho, Kasugai-shi, Aichi,
486-0901, Japan
Phone: +81-(0)568-33-7211
FAX: +81-(0)568-33-2631

Overseas Sales Dept.

Phone: +81-(0)568-33-7861
FAX: +81-(0)568-33-8591