

# 2SD2375

## Silicon NPN triple diffusion planar type

For power amplification with high forward current transfer ratio

### Features

- High forward current transfer ratio  $h_{FE}$  which has satisfactory linearity
- Full-pack package which can be installed to the heat sink with one screw

### Absolute Maximum Ratings ( $T_C=25^\circ\text{C}$ )

Parameter	Symbol	Ratings	Unit
Collector to base voltage	$V_{CBO}$	80	V
Collector to emitter voltage	$V_{CEO}$	60	V
Emitter to base voltage	$V_{EBO}$	6	V
Peak collector current	$I_{CP}$	6	A
Collector current	$I_C$	3	A
Base current	$I_B$	1	A
Collector power dissipation	$P_C$	$T_C=25^\circ\text{C}$	25
		$T_a=25^\circ\text{C}$	2
Junction temperature	$T_j$	150	$^\circ\text{C}$
Storage temperature	$T_{stg}$	-55 to +150	$^\circ\text{C}$

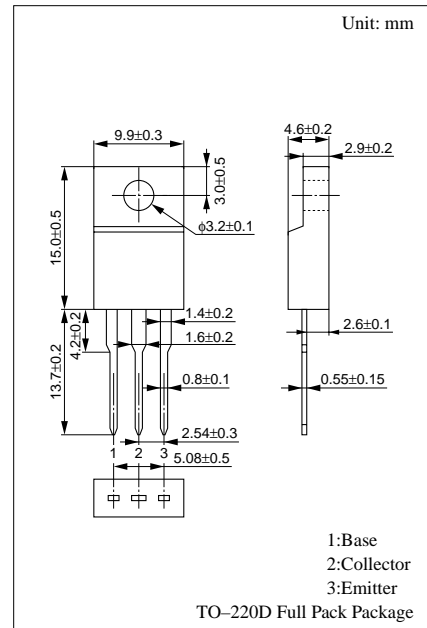

### Electrical Characteristics ( $T_C=25^\circ\text{C}$ )

Parameter	Symbol	Conditions	min	typ	max	Unit
Collector cutoff current	$I_{CBO}$	$V_{CB} = 80\text{V}, I_E = 0$			100	$\mu\text{A}$
	$I_{CEO}$	$V_{CE} = 40\text{V}, I_B = 0$			100	$\mu\text{A}$
Emitter cutoff current	$I_{EBO}$	$V_{EB} = 6\text{V}, I_C = 0$			100	$\mu\text{A}$
Collector to emitter voltage	$V_{CEO}$	$I_C = 25\text{mA}, I_B = 0$	60			V
Forward current transfer ratio	$h_{FE}^*$	$V_{CE} = 4\text{V}, I_C = 0.5\text{A}$	500		1500	
Collector to emitter saturation voltage	$V_{CE(sat)}$	$I_C = 2\text{A}, I_B = 0.05\text{A}$			1	V
Transition frequency	$f_T$	$V_{CE} = 12\text{V}, I_C = 0.2\text{A}, f = 10\text{MHz}$		50		MHz

\* $h_{FE}$  Rank classification

Rank	Q	P
$h_{FE}$	500 to 1000	800 to 1500

Note: Ordering can be made by the common rank (PQ rank  $h_{FE} = 500$  to 1500) in the rank classification.

$P_C - T_a$

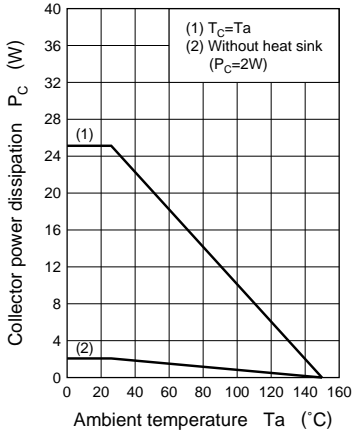

$I_C - V_{CE}$

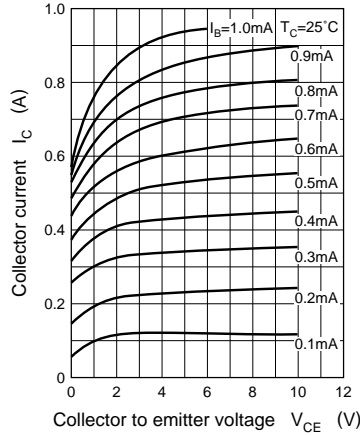

$I_C - V_{BE}$

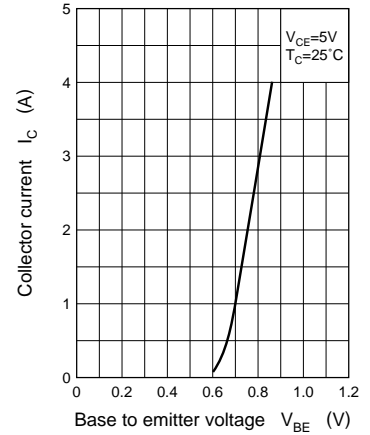

$V_{CE(sat)} - I_C$

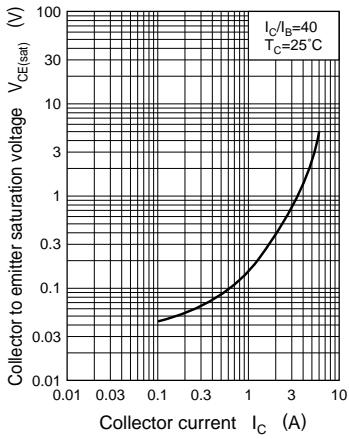

$h_{FE} - I_C$

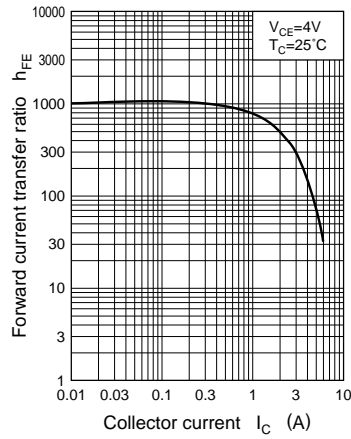

$f_T - I_C$

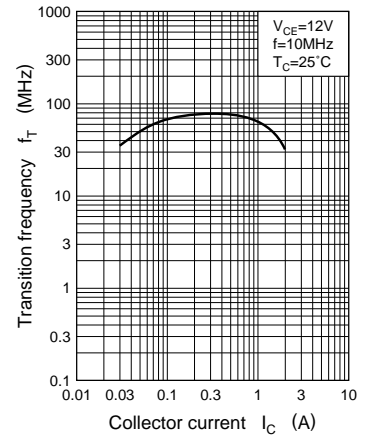

Area of safe operation (ASO)

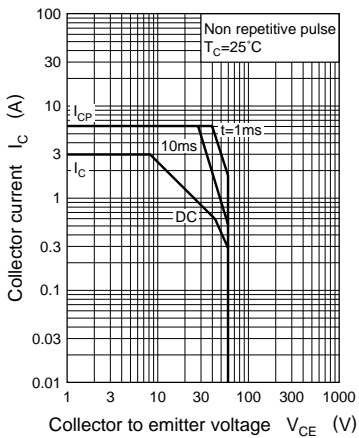

$R_{th(t)} - t$

