

# SN74LS299

## 8-Bit Shift/Storage Register with 3-State Outputs

The SN74LS299 is an 8-Bit Universal Shift/Storage Register with 3-state outputs. Four modes of operation are possible: hold (store), shift left, shift right and load data.

The parallel load inputs and flip-flop outputs are multiplexed to reduce the total number of package pins. Separate outputs are provided for flip-flops Q<sub>0</sub> and Q<sub>7</sub> to allow easy cascading. A separate active LOW Master Reset is used to reset the register.

- Common I/O for Reduced Pin Count
- Four Operation Modes: Shift Left, Shift Right, Load and Store
- Separate Shift Right Serial Input and Shift Left Serial Input for Easy Cascading
- 3-State Outputs for Bus Oriented Applications
- Input Clamp Diodes Limit High-Speed Termination Effects
- ESD > 3500 Volts

### GUARANTEED OPERATING RANGES

Symbol	Parameter	Min	Typ	Max	Unit
V <sub>CC</sub>	Supply Voltage	4.75	5.0	5.25	V
T <sub>A</sub>	Operating Ambient Temperature Range	0	25	70	°C
I <sub>OH</sub>	Output Current – High Q <sub>0</sub> , Q <sub>7</sub>			-0.4	mA
I <sub>OL</sub>	Output Current – Low Q <sub>0</sub> , Q <sub>7</sub>			8.0	mA
I <sub>OH</sub>	Output Current – High I/O <sub>0</sub> – I/O <sub>7</sub>			-2.6	mA
I <sub>OL</sub>	Output Current – Low I/O <sub>0</sub> – I/O <sub>7</sub>			24	mA



ON Semiconductor

<http://onsemi.com>

**LOW  
POWER  
SCHOTTKY**

### MARKING DIAGRAMS

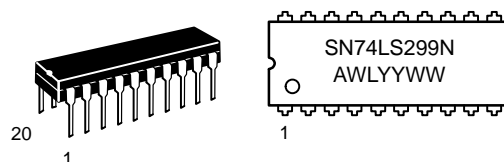

**PDIP-20  
N SUFFIX  
CASE 738**

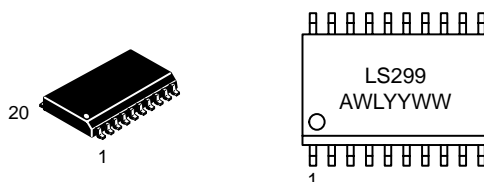

**SOIC-20  
DW SUFFIX  
CASE 751D**

A = Assembly Location  
WL = Wafer Lot  
YY = Year  
WW = Work Week

### ORDERING INFORMATION

Device	Package	Shipping
SN74LS299N	PDIP-20	1440 Units/Box
SN74LS299DW	SOIC-20	2500/Tape & Reel

# SN74LS299

CONNECTION DIAGRAM DIP (TOP VIEW)

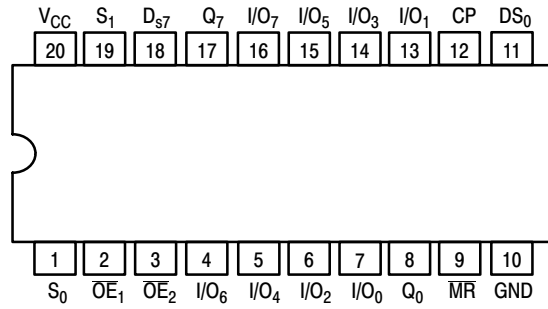

NOTE:  
The Flatpak version has the same pinouts (Connection Diagram) as the Dual In-Line Package.

PIN NAMES		LOADING (Note a)	
		HIGH	LOW
CP	Clock Pulse (Active Positive-Going Edge) Input	0.5 U.L.	0.25 U.L.
DS0	Serial Data Input for Right Shift	0.5 U.L.	0.25 U.L.
DS7	Serial Data Input for Left Shift	0.5 U.L.	0.25 U.L.
I/O <sub>n</sub>	Parallel Data Input or Parallel Output (3-State)	0.5 U.L.	0.25 U.L.
OE <sub>1</sub> , OE <sub>2</sub>	3-State Output Enable (Active LOW) Inputs	0.5 U.L.	0.25 U.L.
Q <sub>0</sub> , Q <sub>7</sub>	Serial Outputs	10 U.L.	5 U.L.
MR	Asynchronous Master Reset (Active LOW) Input	0.5 U.L.	0.25 U.L.
S <sub>0</sub> , S <sub>1</sub>	Mode Select Inputs	1 U.L.	0.5 U.L.



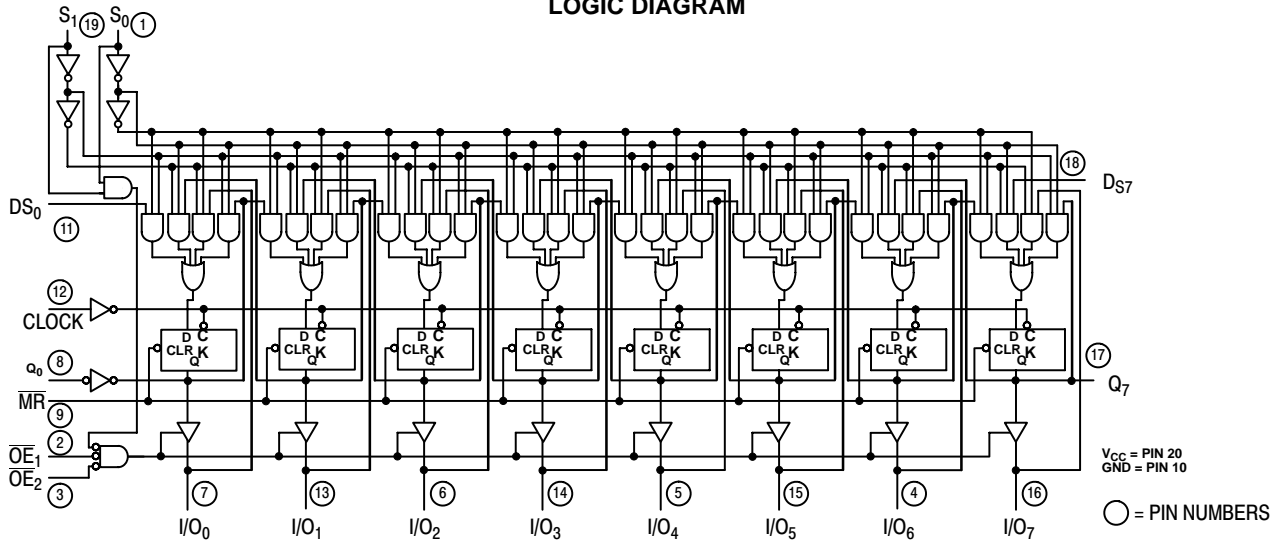

NOTES:  
a) 1 TTL Unit Load (U.L.) = 40  $\mu$ A HIGH/1.6 mA LOW.

LOGIC DIAGRAM



# SN74LS299

## FUNCTION TABLE

INPUTS								RESPONSE
MR	S <sub>1</sub>	S <sub>0</sub>	$\overline{OE}_1$	$\overline{OE}_2$	CP	DS <sub>0</sub>	DS <sub>7</sub>	
L	X	X	H	X	X	X	X	Asynchronous Reset; Q <sub>0</sub> = Q <sub>7</sub> = LOW I/O Voltage Undetermined
L	X	X	X	H	X	X	X	
L	H	H	X	X	X	X	X	
L	L	X	L	L	X	X	X	Asynchronous Reset; Q <sub>0</sub> = Q <sub>7</sub> = LOW I/O Voltage LOW
L	X	L	L	L	X	X	X	
H	L	H	X	X		D	X	Shift Right; D→Q <sub>0</sub> ; Q <sub>0</sub> →Q <sub>1</sub> ; etc. Shift Right; D→Q <sub>0</sub> & I/O <sub>0</sub> ; Q <sub>0</sub> →Q <sub>1</sub> & I/O <sub>1</sub> ; etc.
H	L	H	L	L		D	X	
H	H	L	X	X		X	D	Shift Left; D→Q <sub>7</sub> ; Q <sub>7</sub> →Q <sub>6</sub> ; etc. Shift Left; D→Q <sub>7</sub> & I/O <sub>7</sub> ; Q <sub>7</sub> →Q <sub>6</sub> & I/O <sub>6</sub> ; etc.
H	H	L	L	L		X	D	
H	H	H	X	X		X	X	Parallel Load; I/O <sub>n</sub> →Q <sub>n</sub>
H	L	L	H	X	X	X	X	Hold: I/O Voltage undetermined
H	L	L	X	H	X	X	X	
H	L	L	L	L	X	X	X	Hold: I/O <sub>n</sub> = Q <sub>n</sub>

H = HIGH Voltage Level  
L = LOW Voltage Level  
X = Immaterial

# SN74LS299

## DC CHARACTERISTICS OVER OPERATING TEMPERATURE RANGE (unless otherwise specified)

Symbol	Parameter	Limits			Unit	Test Conditions
		Min	Typ	Max		
V <sub>IH</sub>	Input HIGH Voltage	2.0			V	Guaranteed Input HIGH Voltage for All Inputs
V <sub>IL</sub>	Input LOW Voltage			0.8	V	Guaranteed Input LOW Voltage for All Inputs
V <sub>IK</sub>	Input Clamp Diode Voltage		-0.65	-1.5	V	V <sub>CC</sub> = MIN, I <sub>IN</sub> = -18 mA
V <sub>OH</sub>	Output HIGH Voltage I/O <sub>0</sub> -I/O <sub>7</sub>	2.4	3.1		V	V <sub>CC</sub> = MIN, I <sub>OH</sub> = MAX
V <sub>OH</sub>	Output HIGH Voltage Q <sub>0</sub> , Q <sub>7</sub>	2.7	3.4		V	V <sub>CC</sub> = MIN, I <sub>OH</sub> = MAX
V <sub>OL</sub>	Output LOW Voltage I/O <sub>0</sub> -I/O <sub>7</sub>		0.25	0.4	V	I <sub>OL</sub> = 12 mA
			0.35	0.5	V	I <sub>OL</sub> = 24 mA
V <sub>OL</sub>	Output LOW Voltage I/O <sub>0</sub> -I/O <sub>7</sub>			0.4	V	I <sub>OL</sub> = 4.0 mA
				0.5	V	I <sub>OL</sub> = 8.0 mA
I <sub>OZH</sub>	Output Off Current HIGH I/O <sub>0</sub> -I/O <sub>7</sub>			40	μA	V <sub>CC</sub> = MAX, V <sub>OUT</sub> = 2.7 V
I <sub>OZL</sub>	Output Off Current LOW I/O <sub>0</sub> -I/O <sub>7</sub>			-400	μA	V <sub>CC</sub> = MAX, V <sub>OUT</sub> = 0.4 V
I <sub>IH</sub>	Input HIGH Current	Others		20	μA	V <sub>CC</sub> = MAX, V <sub>IN</sub> = 2.7 V
		S <sub>0</sub> , S <sub>1</sub> , I/O <sub>0</sub> -I/O <sub>7</sub>		40	μA	
		Others		0.1	mA	V <sub>CC</sub> = MAX, V <sub>IN</sub> = 7.0 V
		S <sub>0</sub> , S <sub>1</sub> I/O <sub>0</sub> -I/O <sub>7</sub>		0.2	mA	
				0.1	mA	V <sub>CC</sub> = MAX, V <sub>IN</sub> = 5.5 V
I <sub>IL</sub>	Input LOW Current	Others		-0.4	mA	V <sub>CC</sub> = MAX, V <sub>IN</sub> = 0.4 V
		S <sub>0</sub> , S <sub>1</sub>		-0.8	mA	
I <sub>OS</sub>	Short Circuit Current (Note 1.)	Q <sub>0</sub> , Q <sub>7</sub>	-20	-100	mA	V <sub>CC</sub> = MAX
		I/O <sub>0</sub> -I/O <sub>7</sub>	-30	-130	mA	V <sub>CC</sub> = MAX
I <sub>CC</sub>	Power Supply Current			53	mA	V <sub>CC</sub> = MAX

1. Not more than one output should be shorted at a time, nor for more than 1 second.

# SN74LS299

## AC CHARACTERISTICS ( $T_A = 25^\circ\text{C}$ , $V_{CC} = 5.0\text{ V}$ )

Symbol	Parameter	Limits			Unit	Test Conditions
		Min	Typ	Max		
$f_{MAX}$	Maximum Clock Frequency	25	35		MHz	$C_L = 15\text{ pF}$
$t_{PHL}$ $t_{PLH}$	Propagation Delay, Clock to $Q_0$ or $Q_7$		26 22	39 33	ns	
$t_{PHL}$	Propagation Delay, Clear to $Q_0$ or $Q_7$		27	40	ns	
$t_{PHL}$ $t_{PLH}$	Propagation Delay, Clock to $I/O_0$ – $I/O_7$		26 17	39 25	ns	$C_L = 45\text{ pF}$ , $R_L = 667\ \Omega$
$t_{PHL}$	Propagation Delay, Clear to $I/O_0$ – $I/O_7$		26	40	ns	
$t_{PZH}$ $t_{PZL}$	Output Enable Time		13 19	21 30	ns	
$t_{PHZ}$ $t_{PLZ}$	Output Disable Time		10 10	15 15	ns	$C_L = 5.0\text{ pF}$

## AC SETUP REQUIREMENTS ( $T_A = 25^\circ\text{C}$ , $V_{CC} = 5.0\text{ V}$ )

Symbol	Parameter	Limits			Unit	Test Conditions
		Min	Typ	Max		
$t_W$	Clock Pulse Width HIGH	25			ns	$V_{CC} = 5.0\text{ V}$
$t_W$	Clock Pulse Width LOW	13			ns	
$t_W$	Clear Pulse Width LOW	20			ns	
$t_s$	Data Setup Time	20			ns	
$t_s$	Select Setup Time	35			ns	
$t_h$	Data Hold Time	0			ns	
$t_h$	Select Hold Time	10			ns	
$t_{rec}$	Recovery Time	20			ns	

# SN74LS299

## 3-STATE WAVEFORMS

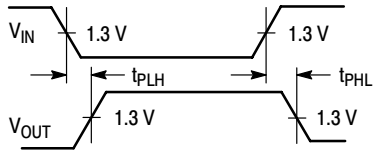

Figure 1.

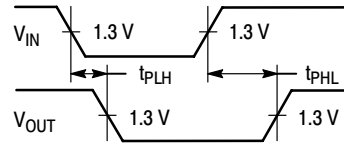

Figure 2.

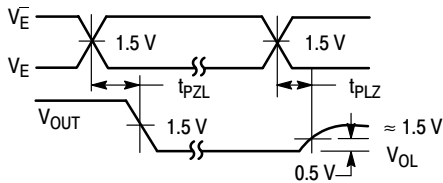

Figure 3.

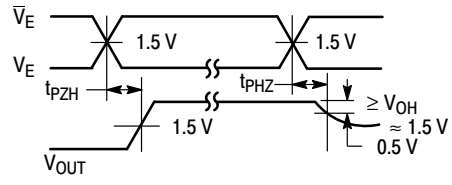
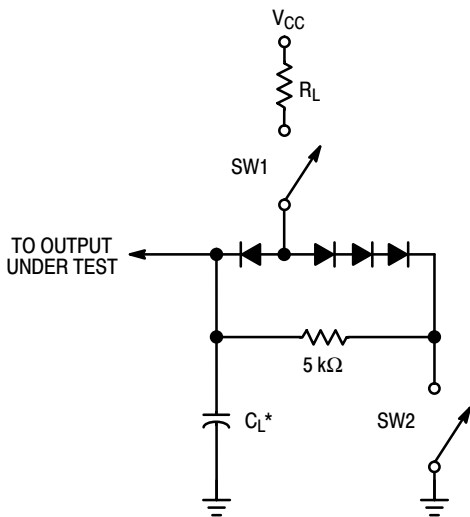

Figure 4.

## AC LOAD CIRCUIT



\* Includes Jig and Probe Capacitance.

Figure 5.

## SWITCH POSITIONS

SYMBOL	SW1	SW2
$t_{PZH}$	Open	Closed
$t_{PZL}$	Closed	Open
$t_{PLZ}$	Closed	Closed
$t_{PHZ}$	Closed	Closed

# SN74LS299

## PACKAGE DIMENSIONS

### N SUFFIX PLASTIC PACKAGE CASE 738-03 ISSUE E

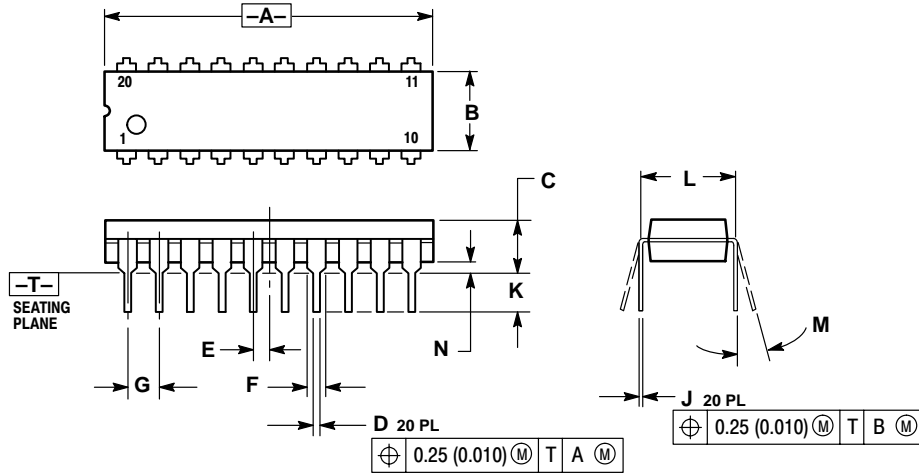

**NOTES:**

1. DIMENSIONING AND TOLERANCING PER ANSI Y14.5M, 1982.
2. CONTROLLING DIMENSION: INCH.
3. DIMENSION L TO CENTER OF LEAD WHEN FORMED PARALLEL.
4. DIMENSION B DOES NOT INCLUDE MOLD FLASH.

DIM	INCHES		MILLIMETERS	
	MIN	MAX	MIN	MAX
A	1.010	1.070	25.66	27.17
B	0.240	0.260	6.10	6.60
C	0.150	0.180	3.81	4.57
D	0.015	0.022	0.39	0.55
E	0.050 BSC		1.27 BSC	
F	0.050	0.070	1.27	1.77
G	0.100 BSC		2.54 BSC	
J	0.008	0.015	0.21	0.38
K	0.110	0.140	2.80	3.55
L	0.300 BSC		7.62 BSC	
M	0°	15°	0°	15°
N	0.020	0.040	0.51	1.01

### D SUFFIX PLASTIC SOIC PACKAGE CASE 751D-05 ISSUE F

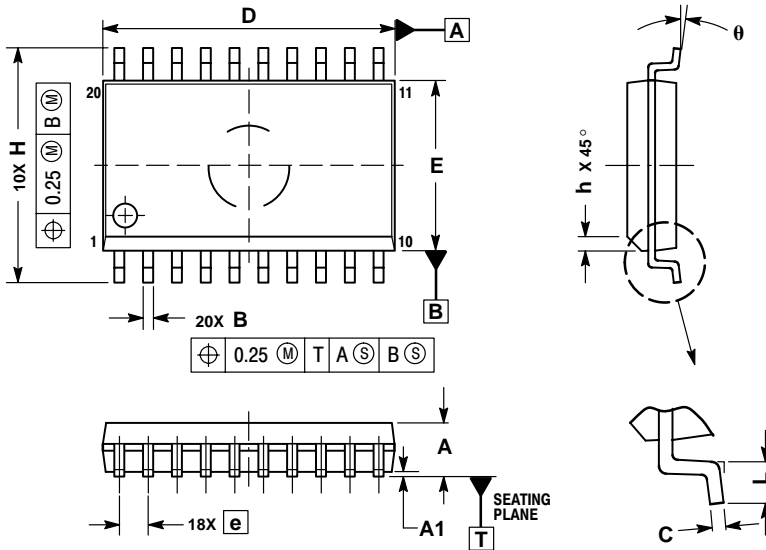

**NOTES:**

1. DIMENSIONS ARE IN MILLIMETERS.
2. INTERPRET DIMENSIONS AND TOLERANCES PER ASME Y14.5M, 1994.
3. DIMENSIONS D AND E DO NOT INCLUDE MOLD PROTRUSION.
4. MAXIMUM MOLD PROTRUSION 0.15 PER SIDE.
5. DIMENSION B DOES NOT INCLUDE DAMBAR PROTRUSION. ALLOWABLE PROTRUSION SHALL BE 0.13 TOTAL IN EXCESS OF B DIMENSION AT MAXIMUM MATERIAL CONDITION.

DIM	MILLIMETERS	
	MIN	MAX
A	2.35	2.65
A1	0.10	0.25
B	0.35	0.49
C	0.23	0.32
D	12.65	12.95
E	7.40	7.60
e	1.27 BSC	
H	10.05	10.55
h	0.25	0.75
L	0.50	0.90
theta	0°	7°

**ON Semiconductor** and  are trademarks of Semiconductor Components Industries, LLC (SCILLC). SCILLC reserves the right to make changes without further notice to any products herein. SCILLC makes no warranty, representation or guarantee regarding the suitability of its products for any particular purpose, nor does SCILLC assume any liability arising out of the application or use of any product or circuit, and specifically disclaims any and all liability, including without limitation special, consequential or incidental damages. "Typical" parameters which may be provided in SCILLC data sheets and/or specifications can and do vary in different applications and actual performance may vary over time. All operating parameters, including "Typicals" must be validated for each customer application by customer's technical experts. SCILLC does not convey any license under its patent rights nor the rights of others. SCILLC products are not designed, intended, or authorized for use as components in systems intended for surgical implant into the body, or other applications intended to support or sustain life, or for any other application in which the failure of the SCILLC product could create a situation where personal injury or death may occur. Should Buyer purchase or use SCILLC products for any such unintended or unauthorized application, Buyer shall indemnify and hold SCILLC and its officers, employees, subsidiaries, affiliates, and distributors harmless against all claims, costs, damages, and expenses, and reasonable attorney fees arising out of, directly or indirectly, any claim of personal injury or death associated with such unintended or unauthorized use, even if such claim alleges that SCILLC was negligent regarding the design or manufacture of the part. SCILLC is an Equal Opportunity/Affirmative Action Employer.

## PUBLICATION ORDERING INFORMATION

### NORTH AMERICA Literature Fulfillment:

Literature Distribution Center for ON Semiconductor  
 P.O. Box 5163, Denver, Colorado 80217 USA  
**Phone:** 303-675-2175 or 800-344-3860 Toll Free USA/Canada  
**Fax:** 303-675-2176 or 800-344-3867 Toll Free USA/Canada  
**Email:** ONlit@hibbertco.com  
 Fax Response Line: 303-675-2167 or 800-344-3810 Toll Free USA/Canada

**N. American Technical Support:** 800-282-9855 Toll Free USA/Canada

**EUROPE:** LDC for ON Semiconductor – European Support

**German Phone:** (+1) 303-308-7140 (Mon-Fri 2:30pm to 7:00pm CET)  
**Email:** ONlit-german@hibbertco.com  
**French Phone:** (+1) 303-308-7141 (Mon-Fri 2:00pm to 7:00pm CET)  
**Email:** ONlit-french@hibbertco.com  
**English Phone:** (+1) 303-308-7142 (Mon-Fri 12:00pm to 5:00pm GMT)  
**Email:** ONlit@hibbertco.com

**EUROPEAN TOLL-FREE ACCESS\*: 00-800-4422-3781**

\*Available from Germany, France, Italy, UK, Ireland

### CENTRAL/SOUTH AMERICA:

**Spanish Phone:** 303-308-7143 (Mon-Fri 8:00am to 5:00pm MST)  
**Email:** ONlit-spanish@hibbertco.com

**ASIA/PACIFIC:** LDC for ON Semiconductor – Asia Support

**Phone:** 303-675-2121 (Tue-Fri 9:00am to 1:00pm, Hong Kong Time)  
**Toll Free** from Hong Kong & Singapore:  
**001-800-4422-3781**  
**Email:** ONlit-asia@hibbertco.com

**JAPAN:** ON Semiconductor, Japan Customer Focus Center

4-32-1 Nishi-Gotanda, Shinagawa-ku, Tokyo, Japan 141-0031  
**Phone:** 81-3-5740-2745  
**Email:** r14525@onsemi.com

**ON Semiconductor Website:** <http://onsemi.com>

For additional information, please contact your local Sales Representative.